













# Outdoor Living

catalogo complementi

# Indice

|          |  |
|----------|--|
| Pag. 6   | Pergole bioclimatiche                                  |
| Pag. 48  | Gazebo   |
| Pag. 70  | Ombrelloni da giardino a palo laterale                 |
| Pag. 111 | Ombrelloni da giardino a palo centrale                 |
| Pag. 145 | Piastre e basi per ombrelloni                          |
| Pag. 146 | Pensiline  |
| Pag. 152 | Complementi in metallo bianco e bianco ossidato        |
| Pag. 165 | Illuminazione: lampade e vasi luminosi                 |
| Pag. 180 | Vasi   |
| Pag. 208 | Panche in ghisa e legno                                |
| Pag. 210 | Articoli in legno di pino impregnato                   |
| Pag. 220 | Casette in legno                                       |
| Pag. 226 | Casette da giardino e articoli in plastica per esterno |
| Pag. 234 | Tappeti e siepi  |
| Pag. 239 | Funghi a gas e barbecue                                |
| Pag. 247 | Accessori per barbecue                                 |
| Pag. 250 | Catering e contract                                    |
| Pag. 259 | Poltrone e sdraio                                      |
| Pag. 270 | Dondoli da giardino                                    |
| Pag. 276 | Teli di ricambio per dondoli                           |
| Pag. 278 | Teli di copertura                                      |
| Pag. 283 | Giochi da giardino                                     |

# Legenda

|   |                             |
|---|-----------------------------|
|    | Dimensioni                  |
|    | Peso                        |
|    | Numero pezzi per confezione |
|    | Struttura e diametro tubi   |
|    | Struttura e dimensioni      |
|    | Portata massima             |
|    | Tessuto/materiale           |
|  | Spessore del piano          |
|  | Tipo di piano               |
|  | Altezza del piano           |



Outdoor Living  
catalogo complementi

## CHE COS'È IL SERVIZIO DROP SHIPPING?

Il drop shipping è la vendita di prodotti ai clienti tramite un fornitore terzo che detiene l'inventario e provvede alla spedizione degli ordini. Gli imprenditori che lavorano in drop shipping si concentrano sul branding, sul marketing e sulla gestione dei clienti, mentre è il fornitore a gestire la logistica per loro

Ordine: il cliente ordina un articolo nel tuo store  
Trasmissione dell'ordine: ci trasmetterai gli ordini ricevuti  
Preparazione: prepareremo i tuoi ordini in 2 giorni lavorati  
Spedizione: affideremo al corriere i prodotti

### QUALI SONO I VANTAGGI PER LA TUA AZIENDA?

Questo tipo di operazione permette di pubblicare e quindi vendere sul proprio portale e-commerce, tutti i prodotti dell'assortimento del fornitore, senza dover impegnare risorse di tipo finanziario, personale, logistico.

### COME FUNZIONA IL SERVIZIO DROP SHIPPING DI MAGAZZINI COSMA?

#### IMPOSTAZIONE

Magazzini Cosma fornisce al cliente la propria anagrafica articoli con dei file .csv. I file sono pubblicati su URL, regolarmente aggiornati.

Al cliente viene comunicato lo sconto da calcolare sul prezzo di listino indicato nell'apposito .csv. Il dato di giacenza è già calcolato con un prudente sotto scorta per garantire la sicurezza che il prodotto venduto, sia effettivamente disponibile presso il magazzino di Magazzini Cosma. Il file con le anagrafiche articoli è popolato con tutti i dati necessari alla vendita, in particolare nell'apposita colonna sono presenti tutti i link alle immagini prodotto, con relativi dettagli. Sono inclusi i dati di peso e volume affinché il cliente possa calcolare il costo della spedizione e creare la relativa Lettera Di Vettura.

#### GESTIONE ORDINI

Esistono due distinte modalità di trasmissione degli ordini drop shipping:

- Tramite il portale B2B dell'azienda: <https://b2b.magazzinicosma.it>
- Tramite trasmissione di un apposito tracciato .csv sull'FTP dell'azienda

Nel primo caso, una volta effettuato il login con le proprie credenziali di accesso, è possibile creare l'ordine in modalità "DROP", con le normali modalità di un qualsiasi sito e-commerce.

Al check-out, il sistema impone di allegare relativa LDV e una nota di riferimento ordine.

Nel secondo caso, al cliente verrà fornito il tracciato .csv con le relative istruzioni sulla compilazione e trasmissione al ns. FTP.

È evidente che la trasmissione tramite .csv è la soluzione per coloro che vogliono automatizzare il più possibile la trasmissione degli ordini, evitando l'intervento umano.

## SPEDIZIONI

Ai fini dell'assistenza e del customer care rispetto al cliente finale, è il rivenditore che deve necessariamente essere il titolare della spedizione. Deve poter scegliere a quale corriere affidare il trasporto ed è essere informato su tutte le varie fasi della consegna.

Magazzini Cosma deve quindi ricevere dal rivenditore la LDV relativa ad ogni singolo ordine inviato.

Il cliente riceverà istruzioni su come trasmettere e nominare i file .pdf delle LDV sul ns. FTP.

Magazzini Cosma è in grado tuttavia di fornire al cliente un ulteriore servizio, per far fronte alla scomodità tecnica dell'invio delle LDV, e per ovviare alla difficoltà nell'ottenere tariffe convenienti dai corrieri espressi, anche per colli particolarmente voluminosi come sono i ns. articoli.

Qualora il rivenditore fosse interessato, verranno sottoposte delle tariffe del corriere SDA e BRT appositamente studiate con questi ultimi, affinché sia possibile generare le LDV da parte di Magazzini Cosma in autonomia, nonostante la titolarità della spedizione si manterrà invece del rivenditore che riceverà fattura dal corriere a fine mese.

#### Perché solo SDA e BRT?

Per efficientare e gestire le operazioni di carico, l'azienda ha stipulato un accordo con entrambe le compagnie di cui sopra, affinché ogni giorno posizionino i propri semirimorchi in azienda, permettendo di caricare la merce appena pronta.

Questo permette al cliente di non dover avere l'onere di prenotare il ritiro della merce per la spedizione, e abbatta considerevolmente i tempi di consegna.

#### Tempi di consegna

Dalla ricezione dell'ordine e relativa lettera di vettura (LDV), l'azienda imballa e spedisce in un periodo di tempo medio di 3 gg lavorativi.

#### Modalità di imballo

Da anni abbiamo perfezionato il sistema di imballaggio strutturando l'azienda con personale addestrato e sistemi automatizzati.

La stragrande maggioranza degli articoli richiede infatti un ulteriore imballo per abbattere l'incidenza dei danneggiamenti dovuti all'incuria dei corrieri. Questo sistema richiede un enorme entità di investimento che l'azienda ha già sviluppato, il cliente che ne usufruisce risparmia sensibilmente.

#### Trasporto

In caso di danneggiamenti e/o resi dovuti all'incuria del corriere, sarà il cliente a gestire e a subire il danno. Chiaramente grazie agli imballi particolari, l'incidenza di queste problematiche sarà abbattuta considerevolmente rispetto all'alternativa.

#### Disponibilità pronta consegna

E' il dato di disponibilità di ogni articolo presente fisicamente nei ns. magazzini, depurato da qualsiasi impegno di consegna, garantendo al cliente che il pezzo venduto sia a disposizione per la spedizione immediata.



Outdoor Living  
catalogo complementi





Pergole bioclimatiche



GA802107-MRNE

**PERGOLA BIOCLIMATICA 3 X 4**

MARRONE EFFETTO LEGNO



8 057635 313915

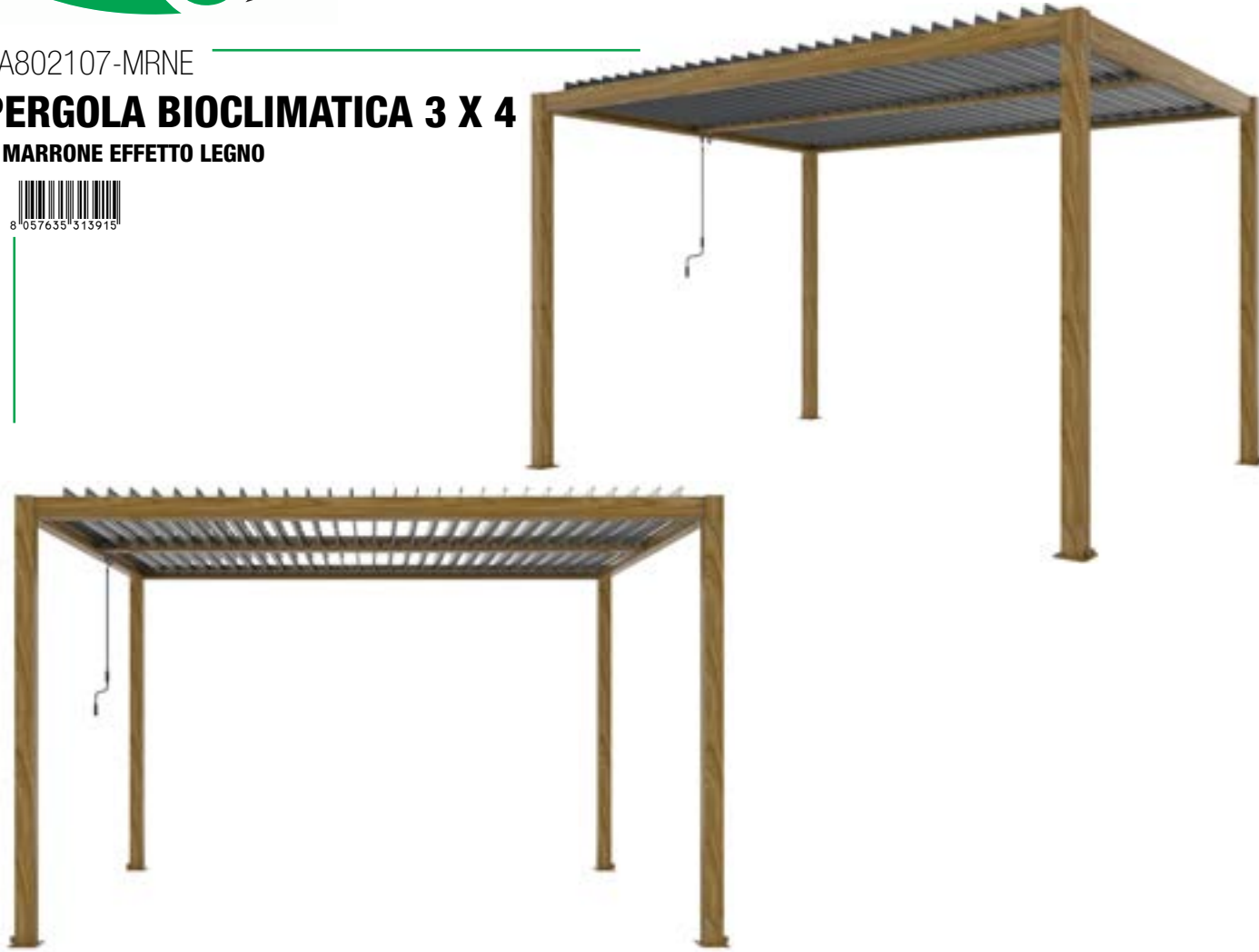

m 3 x 4 x 2,5 h ↗  
pali 100x100 mm  
basi di ancoraggio 160x160 mm  
lamelle frangisole 23 x 145 x 1,4 mm

173

1

Struttura in alluminio marrone effetto legno, copertura a lamelle frangisole antracite orientabili a movimentazione manuale, resistente a tutte le intemperie



GA802108-BIAN

**PERGOLA BIOCLIMATICA 4x4**

BIANCO

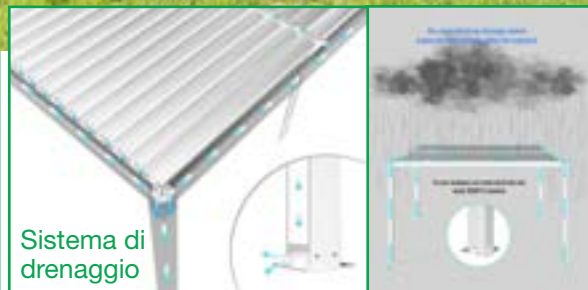

Cm tot. 395,8 x 395,8 x 250 h  
tetto: 389,8 x 389,8 / pali 10x10 cm

172

1

Struttura in alluminio bianco  
copertura a lamelle frangisole orientabili  
a movimentazione manuale  
resistente a tutte le intemperie

GA802107-BIAN

**PERGOLA BIOCLIMATICA 3x4**

BIANCO

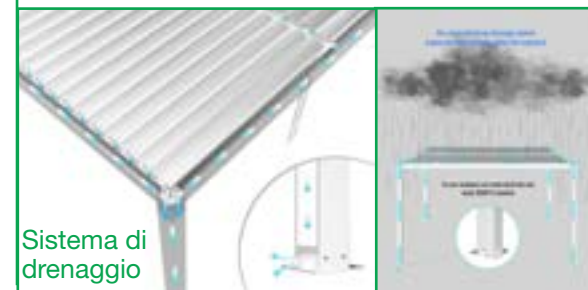

Cm tot. 296,6 x 395,8 x 250 h  
tetto: 290,6 x 389,8 / pali 10x10 cm

145

1

Struttura in alluminio bianco  
copertura a lamelle frangisole orientabili  
a movimentazione manuale  
resistente a tutte le intemperie



GA802122-BIAN

**PERGOLA BIOCLIMATICA 3x3**

BIANCO



8 051811 469410

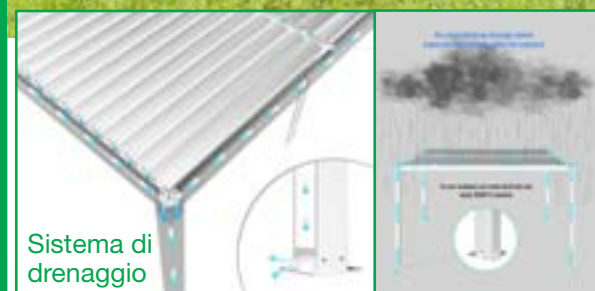

Sistema di drenaggio



Cm tot. 296,6 x 296,6 x 250 h  
tetto: 290,6 x 290,6/ pali 10x10 cm

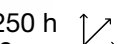

172



1

Struttura in alluminio BIANCO  
copertura a lamelle frangisole orientabili  
a movimentazione manuale  
resistente a tutte le intemperie

GA802122-DGRE

**PERGOLA BIOCLIMATICA 3x3**

GRIGIO SCURO



8 051811 469427



Sistema di drenaggio



Cm tot. 296,6 x 296,6 x 250 h  
tetto: 290,6 x 290,6/ pali 10x10 cm



172



1

Struttura in alluminio GRIGIO SCURO  
copertura a lamelle frangisole orientabili  
a movimentazione manuale  
resistente a tutte le intemperie



GA802108-DGRE

**PERGOLA BIOCLIMATICA 4x4**

GRIGIO SCURO



8 051811 461049

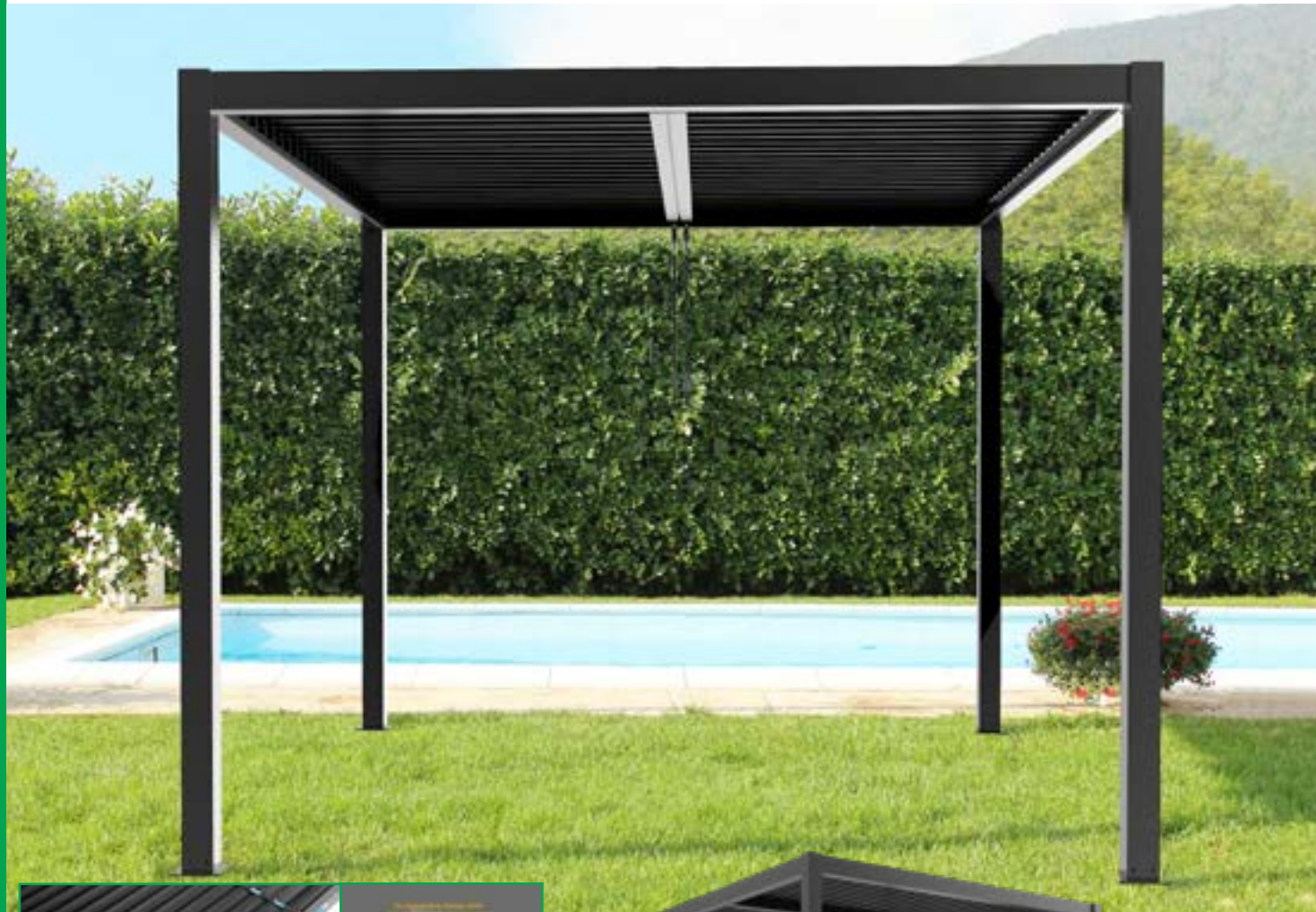

Sistema di drenaggio



Cm tot. 395,8 x 395,8 x 250 h/  
tetto: 389,8 x 389,8 / pali 10 x 10 cm

172

1

Struttura in alluminio GRIGIO SCURO  
copertura a lamelle frangisole orientabili  
a movimentazione manuale  
resistente a tutte le intemperie

GA802107-DGRE

**PERGOLA BIOCLIMATICA 3x4**

GRIGIO SCURO



8 051811 461025

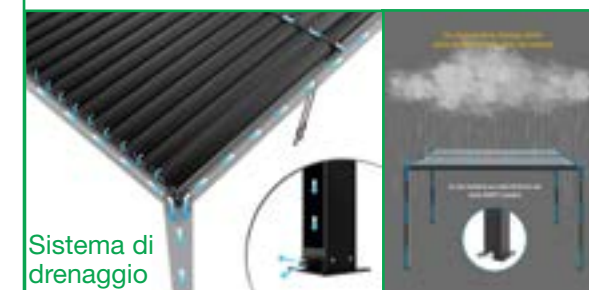

Sistema di drenaggio

Cm tot. 296,6 x 395,8 x 250 h/  
tetto: 290,6 x 389,8 / pali 10 x 10 cm

145

1

Struttura in alluminio GRIGIO SCURO  
copertura a lamelle frangisole orientabili  
a movimentazione manuale  
resistente a tutte le intemperie



GA802141-BIAN

**PERGOLA BIOCLIMATICA 7,8 X 4**

BIANCO



Cm tot. 780 x 395 x 250 h/ pali 100 x 100 X 1,6 mm/  
basi di ancoraggio 160x160 mm

396

1

Struttura in alluminio BIANCO   
copertura a lamelle frangisole orientabili  
a movimentazione manuale  
resistente a tutte le intemperie

GA802141-DGRE

**PERGOLA BIOCLIMATICA 7,8 X 4**

GRIGIO SCURO



Cm tot. 780 x 395 x 250 h/ pali 100 x 100 X 1,6 mm/  
basi di ancoraggio 160x160 mm

396

1

Struttura in alluminio GRIGIO SCURO   
copertura a lamelle frangisole orientabili  
a movimentazione manuale  
resistente a tutte le intemperie



GA802140-BIAN

**PERGOLA BIOCLIMATICA 5,8 X 3**

BIANCO



8 057635 313359

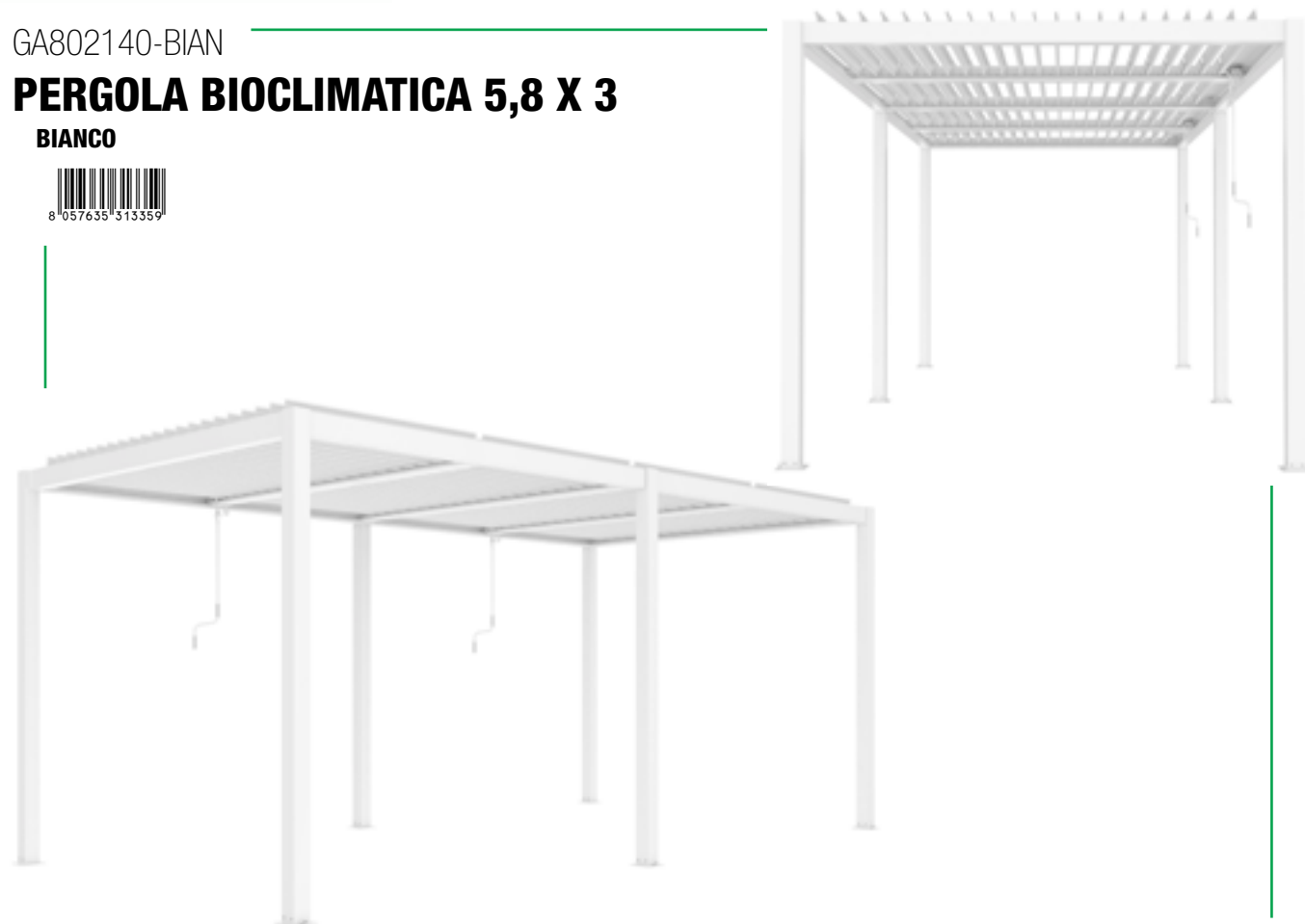

Cm tot. cm 580 x 296 x 250 h/ pali 100 x 100 X 1,6 mm/  
basi di ancoraggio 160x160 mm

263

1

Struttura in alluminio BIANCO  
copertura a lamelle frangisole orientabili  
a movimentazione manuale  
resistente a tutte le intemperie

GA802140-DGRE

**PERGOLA BIOCLIMATICA 5,8 X 3**

GRIGIO SCURO



8 057635 313366



Cm tot. cm 580 x 296 x 250 h/ pali 100 x 100 X 1,6 mm/  
basi di ancoraggio 160x160 mm

263

1

Struttura in alluminio GRIGIO SCURO  
copertura a lamelle frangisole orientabili  
a movimentazione manuale  
resistente a tutte le intemperie



GA802121-BIAN

**PERGOLA BIOCLIMATICA 4 X 4 MOTORIZZATA CON LED**

BIANCA



8 051811 469366

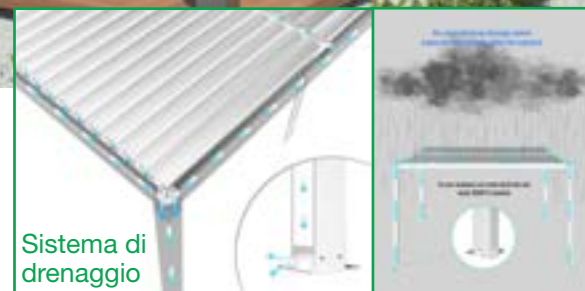

Sistema di drenaggio

m 4 x 4 x 2,5 h / pali 12x12 cm

223

1

Struttura in alluminio BIANCO  
copertura a lamelle frangisole  
orientabili a movimentazione elettrica  
con led e controllo da APP

GA802120-BIAN

**PERGOLA BIOCLIMATICA 3 X 4 MOTORIZZATA CON LED**

BIANCA



8 051811 469342

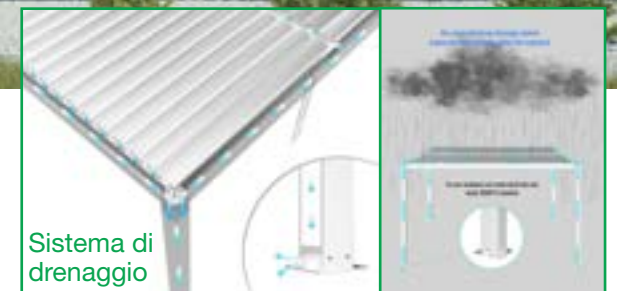

Sistema di drenaggio

m 3 x 4 x 2,5 h / pali 12x12 cm

165

1

Struttura in alluminio BIANCO  
copertura a lamelle frangisole  
orientabili a movimentazione elettrica  
con led e controllo da APP



GA802121-DGRE

**PERGOLA BIOCLIMATICA 4 X 4 MOTORIZZATA CON LED**

GRIGIO SCURO



GA802120-DGRE

**PERGOLA BIOCLIMATICA 3 X 4 MOTORIZZATA CON LED**

GRIGIO SCURO

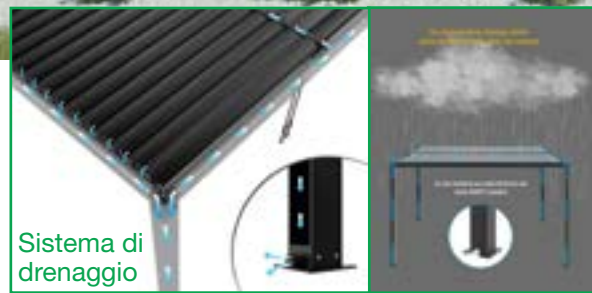

Sistema di drenaggio



Sistema di drenaggio



m 4 x 4 x 2,5 h/ pali 12x12 cm

223

1

Struttura in alluminio GRIGIO SCURO  
copertura a lamelle frangisole orientabili a  
movimentazione elettrica  
con led e controllo da APP



m 3 x 4 x 2,5 h / pali 12x12 cm

165

1

Struttura in alluminio GRIGIO SCURO  
copertura a lamelle frangisole orientabili a  
movimentazione elettrica  
con led e controllo da APP



GA802119-BIAN

**PERGOLA BIOCLIMATICA 4 X 4 ADDOSSATA**

**BIANCO**



8 051811 469328

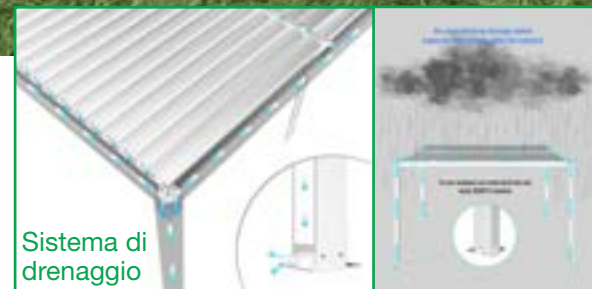

Sistema di drenaggio

m 4 x 4 x 2,5 h / pali 10x10 cm ↗

179,3

1

Struttura in alluminio BIANCO   
copertura a lamelle frangisole orientabili  
a movimentazione manuale  
resistente a tutte le intemperie

GA802119-DGRE

**PERGOLA BIOCLIMATICA 4 X 4 ADDOSSATA**

**GRIGIO SCURO**



8 051811 469335

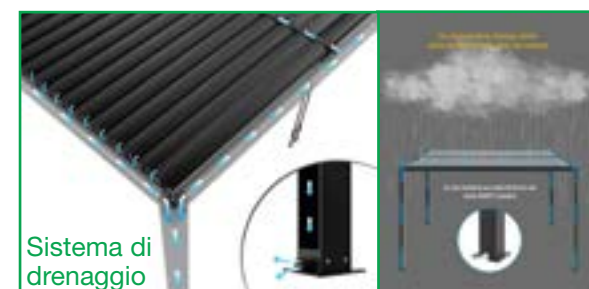

Sistema di drenaggio

m 4 x 4 x 2,5 h / pali 10x10 cm ↗

179,3

1

Struttura in alluminio GRIGIO SCURO   
copertura a lamelle frangisole orientabili  
a movimentazione manuale  
resistente a tutte le intemperie



GA802118-BIAN

**PERGOLA BIOCLIMATICA 3 X 4 ADDOSSATA**

**BIANCO**



8 051811 469304

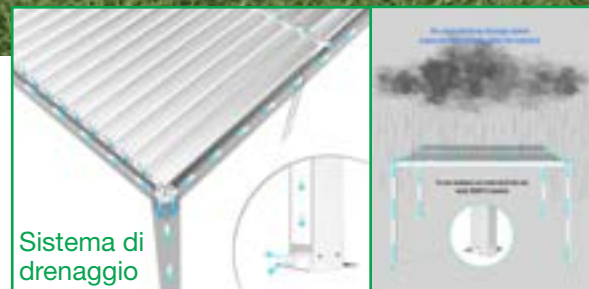

Sistema di drenaggio

m 3 x 4 x 2,5 h / pali 10x10 cm ↗

120,9

1

Struttura in alluminio BIANCO   
copertura a lamelle frangisole orientabili  
a movimentazione manuale  
resistente a tutte le intemperie

GA802118-DGRE

**PERGOLA BIOCLIMATICA 3 X 4 ADDOSSATA**

**GRIGIO SCURO**



8 051811 469311

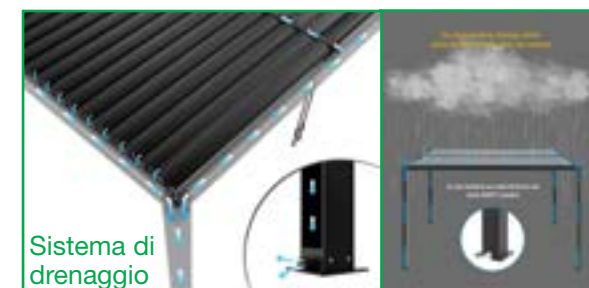

Sistema di drenaggio

m 3 x 4 x 2,5 h / pali 10x10 cm ↗

120,9

1

Struttura in alluminio GRIGIO SCURO   
copertura a lamelle frangisole orientabili  
a movimentazione manuale  
resistente a tutte le intemperie



**ACCESSORI PER PERGOLE BIOCLIMATICHE**

GA802111-BIAN **LATERALE PER LATO DA 3M**  
Cm 270x238, laterale manuale in textilene BIANCO con bordo inferiore in alluminio 25,9x53mm guide in metallo, contenitore 83x83.8mm



GA802111-DGRE **LATERALE PER LATO DA 3M**  
Cm 270 x 238, laterale manuale in textilene grigio scuro con bordo inferiore in alluminio 25,9x53mm, guide in metallo, contenitore 83x83.8mm



GA802146-MRNE **LATERALE SCORREVOLE DA 3M CON LAMELLE PER PERGOLA BIOCLIMATICA**  
Laterale scorrevole per lato da 3 metri, con struttura in alluminio grigio scuro e lamelle orientabili in alluminio effetto legno cm 270 x 238



GA802112-BIAN **LATERALE PER LATO DA 4M**  
Cm 370x238, laterale manuale in textilene BIANCO con bordo inferiore in alluminio 25,9x53mm guide in metallo, contenitore 83x83.8mm



GA802112-DGRE **LATERALE PER LATO DA 4M**  
Cm 370x238, laterale manuale in textilene grigio scuro con bordo inferiore in alluminio 25,9x53mm guide in metallo, contenitore 83x83.8mm



GA802123-BIAN **LATERALE PER LATO DA 3M IN PVC**  
cm 270x238, laterale manuale in PVC trasparente, con avvolgitore bianco



GA802123-DGRE **LATERALE PER LATO DA 3M IN PVC**  
cm 270 x 238, laterale manuale in PVC trasparente, con avvolgitore grigio scuro



GA802124-BIAN **LATERALE PER LATO DA 4M PVC**  
Cm 370x238, laterale manuale in PVC trasparente, con avvolgitore bianco



GA802124-DGRE **LATERALE PER LATO DA 4M PVC**  
Cm 370x238, laterale manuale in PVC trasparente, con avvolgitore grigio scuro



GA802125 **LED PER PERGOLA BIOCLIMATICA 3X3**  
Led con luce calda con 4 strisce + 4 copertina, alimentatore, connettore e telecomando



GA802126 **LED PER PERGOLA BIOCLIMATICA 3X4**  
Led con luce calda con 4 strisce + 4 copertina, alimentatore, connettore e telecomando



GA802127 **LED PER PERGOLA BIOCLIMATICA 4X4**  
Led con luce calda con 4 strisce + 4 copertina, alimentatore, connettore e telecomando



GA802135 **MOTORE DI RICAMBIO PER PERGOLA BIOCLIMATICA MOTORIZZATA**  
Motore, scatola di controllo e cavo



GA802146-BIAN **LATERALE SCORREVOLE DA 3M CON LAMELLE PER PERGOLA BIOCLIMATICA**  
Laterale scorrevole per lato da 3 metri in alluminio bianco con lamelle orientabili cm 270 x 238



GA802147-BIAN **LATERALE SCORREVOLE DA 4M CON LAMELLE PER PERGOLA BIOCLIMATICA**  
Laterale scorrevole per lato da 4 metri in alluminio bianco con lamelle orientabili cm 370 x 238



GA802146-DGRE **LATERALE SCORREVOLE DA 3M CON LAMELLE PER PERGOLA BIOCLIMATICA**  
Laterale scorrevole per lato da 3 metri in alluminio bianco con lamelle orientabili cm 270 x 238



GA802147-DGRE **LATERALE SCORREVOLE DA 4M CON LAMELLE PER PERGOLA BIOCLIMATICA**  
Laterale scorrevole per lato da 3 metri in alluminio bianco con lamelle orientabili cm 370 x 238





GA802147-MRNE

**LATERALE SCORREVOLE DA 4M CON LAMELLE PER PERGOLA BIOCLIMATICA**



Laterale scorrevole per lato da 4 metri, con struttura in alluminio grigio scuro e lamelle orientabili in alluminio effetto legno cm 370 x 238



GA802148-DGRE

**LATERALE SCORREVOLE DA 3M CON VETRO PER PERGOLA BIOCLIMATICA**



Composto da 3 pannelli scorrevoli e indipendenti, in alluminio grigio scuro e vetro  
Misura totale della parete: 270 x 238 cm



GA802149-BIAN

**LATERALE SCORREVOLE DA 4M CON VETRO PER PERGOLA BIOCLIMATICA**



Composto da 3 pannelli scorrevoli e indipendenti, in alluminio bianco e vetro  
Misura totale della parete: 370 x 238 cm



GA802148-BIAN

**LATERALE SCORREVOLE DA 3M CON VETRO PER PERGOLA BIOCLIMATICA**



Composto da 3 pannelli scorrevoli e indipendenti, in alluminio bianco e vetro  
Misura totale della parete: 270 x 238 cm



GA802149-DGRE

**LATERALE SCORREVOLE DA 4M CON VETRO PER PERGOLA BIOCLIMATICA**



Composto da 3 pannelli scorrevoli e indipendenti, in alluminio grigio scuro e vetro  
Misura totale della parete: 370 x 238 cm

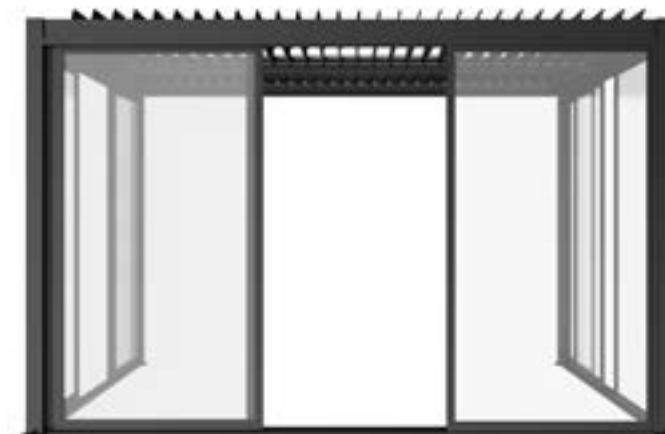



GA802136-BIAN

**PERGOLA BIOCLIMATICA 3x3 CON DOPPIA LAMELLA**

BIANCO



↗ m 3 x 3 x 2,4 h  
pali mm 110x110 spessore alluminio 1,5  
lamelle frangisole 2800 x 175 x 32 mm  
spessore alluminio 1,2 mm

- ⊗ Struttura in alluminio BIANCO  
copertura a lamelle frangisole orientabili  
a movimentazione manuale  
resistente a tutte le intemperie

GA802137-BIAN

**PERGOLA BIOCLIMATICA 3x4 CON DOPPIA LAMELLA**

BIANCO



↗ m 3 x 4 x 2,4 h  
pali mm 110x110 spessore alluminio 1,5  
lamelle frangisole 2800 x 175 x 32 mm  
spessore alluminio 1,2 mm

- ⊗ Struttura in alluminio BIANCO  
copertura a lamelle frangisole orientabili  
a movimentazione manuale  
resistente a tutte le intemperie



GA802136-DGRE

**PERGOLA BIOCLIMATICA 3x3 CON DOPPIA LAMELLA**

GRIGIO SCURO



↗ m 3 x 3 x 2,4 h  
pali mm 110x110 spessore alluminio 1,5  
lamelle frangisole 2800 x 175 x 32 mm  
spessore alluminio 1,2 mm

- ⊗ Struttura in alluminio GRIGIO SCURO  
copertura a lamelle frangisole orientabili  
a movimentazione manuale  
resistente a tutte le intemperie

GA802137-DGRE

**PERGOLA BIOCLIMATICA 3x4 CON DOPPIA LAMELLA**

GRIGIO SCURO



↗ m 3 x 4 x 2,4 h  
pali mm 110x110 spessore alluminio 1,5  
lamelle frangisole 2800 x 175 x 32 mm  
spessore alluminio 1,2 mm

- ⊗ Struttura in alluminio GRIGIO SCURO  
copertura a lamelle frangisole orientabili  
a movimentazione manuale  
resistente a tutte le intemperie



GA802150-BIAN

**LATERALE IN TEXTILENE PER LATO DA 3 M PERGOLA BIOCLIMATICA CON DOPPIA LAMELLA**



Laterale manuale in textilene BIANCO  
cm 281 x 221



GA802150-DGRE

**LATERALE IN TEXTILENE PER LATO DA 3 M PERGOLA BIOCLIMATICA CON DOPPIA LAMELLA**



Laterale manuale in textilene GRIGIO SCURO  
cm 281 x 221



GA802151-BIAN

**LATERALE IN TEXTILENE PER LATO DA 4 M PERGOLA BIOCLIMATICA CON DOPPIA LAMELLA**



Laterale manuale in textilene BIANCO  
cm 371 x 221



GA802151-DGRE

**LATERALE IN TEXTILENE PER LATO DA 4 M PERGOLA BIOCLIMATICA CON DOPPIA LAMELLA**



Laterale manuale in textilene GRIGIO SCURO  
cm 371 x 221



GA802128-BIAN

**PERGOLA BIOCLIMATICA 3x3 ELLE**

**BIANCO**



m 3 x 3 x 2,3 h ↗  
pali 100x100x2290mm spessore allu.1,5 mm  
basi di ancoraggio 160x160 mm  
lamelle frangisole 2900 x 870 x 15 mm  
spessore allu. 0,9 mm

Struttura in alluminio BIANCO, copertura a lamelle frangisole bianche orientabili a movimentazione manuale, resistente a tutte le intemperie ↗

GA802128-DGRE

**PERGOLA BIOCLIMATICA 3x3 ELLE**

**GRIGIO SCURO**



m 3 x 3 x 2,3 h ↗  
pali 100x100x2290mm spessore allu.1,5 mm  
basi di ancoraggio 160x160 mm  
lamelle frangisole 2900 x 870 x 15 mm  
spessore allu. 0,9 mm

Struttura in alluminio GRIGIO SCURO, copertura a lamelle frangisole bianche orientabili a movimentazione manuale, resistente a tutte le intemperie ↗



GA802129-BIAN

**PERGOLA BIOCLIMATICA 3x4 ELLE**

BIANCO

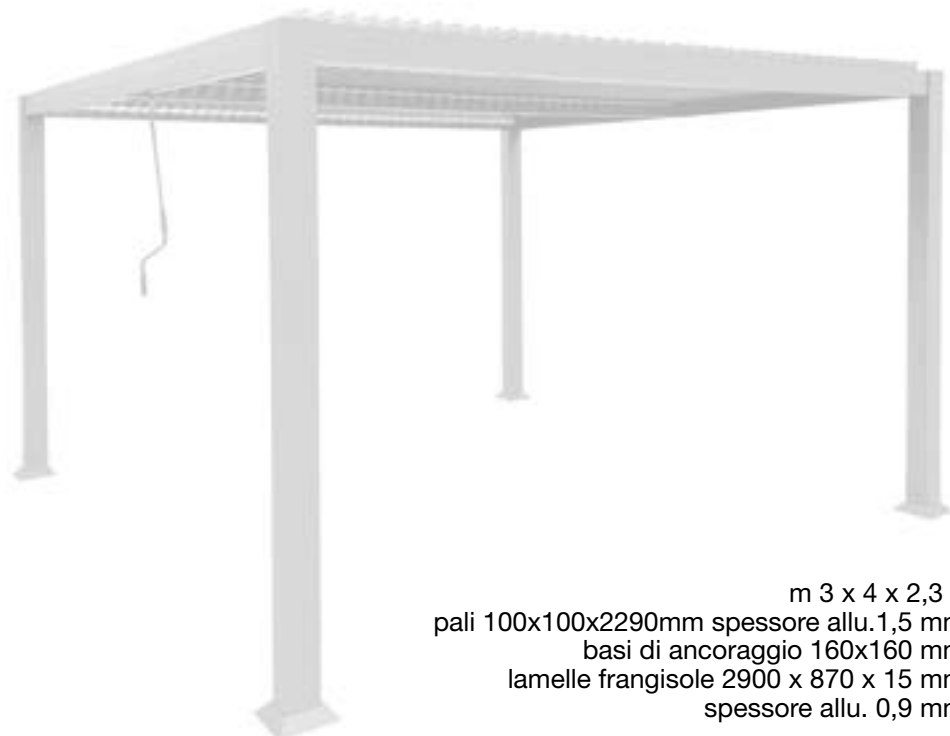

m 3 x 4 x 2,3 h ↗  
pali 100x100x2290mm spessore allu.1,5 mm  
basi di ancoraggio 160x160 mm  
lamelle frangisole 2900 x 870 x 15 mm  
spessore allu. 0,9 mm

Struttura in alluminio BIANCO, copertura a lamelle frangisole bianche orientabili a movimentazione manuale, resistente a tutte le intemperie ☑

GA802134-BIAN

**PERGOLA BIOCLIMATICA 4x4 ELLE**

BIANCO



m 3 x 4 x 2,3 h ↗  
pali 100x100x2290mm spessore allu.1,5 mm  
basi di ancoraggio 160 x 160 mm  
lamelle frangisole 3970 x 870 x 15 mm  
spessore allu. 0,9 mm

Struttura in alluminio BIANCO, copertura a lamelle frangisole bianche orientabili a movimentazione manuale, resistente a tutte le intemperie ☑

GA802129-DGRE

**PERGOLA BIOCLIMATICA 3x4 ELLE**

GRIGIO SCURO



m 3 x 4 x 2,3 h ↗  
pali 100x100x2290mm spessore allu.1,5 mm  
basi di ancoraggio 160x160 mm  
lamelle frangisole 2900 x 870 x 15 mm  
spessore allu. 0,9 mm

Struttura in alluminio GRIGIO SCURO, copertura a lamelle frangisole bianche orientabili a movimentazione manuale, resistente a tutte le intemperie ☑

GA802134-DGRE

**PERGOLA BIOCLIMATICA 4x4 ELLE**

GRIGIO SCURO



m 3 x 4 x 2,3 h ↗  
pali 100x100x2290mm spessore allu.1,5 mm  
basi di ancoraggio 160x160 mm  
lamelle frangisole 3970 x 870 x 15 mm  
spessore allu. 0,9 mm

Struttura in alluminio GRIGIO SCURO, copertura a lamelle frangisole bianche orientabili a movimentazione manuale, resistente a tutte le intemperie ☑



GA802139-BIAN

**MODULO PER ESTENSIONE PERGOLA BIOCLIMATICA 3x3 ELLE**

**BIANCO**



m 3 x 3 x 2,3 h ↗  
pali 100x100x2290mm spessore allu.1,5 mm  
basi di ancoraggio 160x160 mm  
lamelle frangisole 2900 x 870 x 15 mm  
spessore allu. 0,9 mm

Struttura in alluminio BIANCO, copertura a lamelle frangisole bianche orientabili a movimentazione manuale, resistente a tutte le intemperie ↗

GA802139-DGRE

**MODULO PER ESTENSIONE PERGOLA BIOCLIMATICA 3x3 ELLE**

**GRIGIO SCURO**

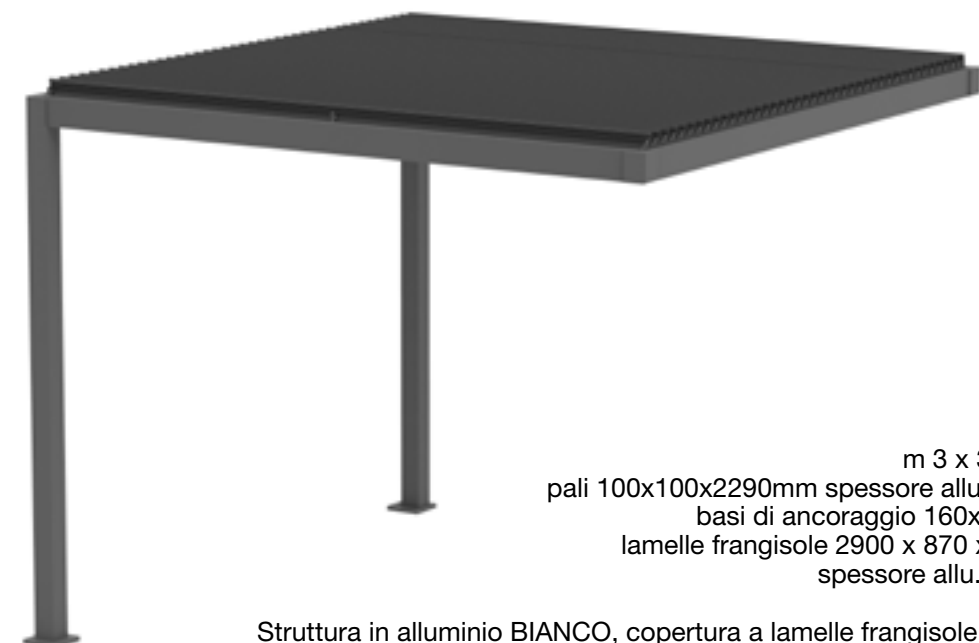

m 3 x 3 x 2,3 h ↗  
pali 100x100x2290mm spessore allu.1,5 mm  
basi di ancoraggio 160x160 mm  
lamelle frangisole 2900 x 870 x 15 mm  
spessore allu. 0,9 mm

Struttura in alluminio BIANCO, copertura a lamelle frangisole bianche orientabili a movimentazione manuale, resistente a tutte le intemperie ↗

GA802133-BIAN

**LATERALE IN TEXTILENE PER LATO DA 3M PER PERGOLA BIOCLIMATICA ELLE**



Laterale manuale in textilene BIANCO  
cm 287 x 200



GA802133-DGRE

**LATERALE IN TEXTILENE PER LATO DA 3M PER PERGOLA BIOCLIMATICA ELLE**



Laterale manuale in textilene GRIGIO SCURO  
cm 287 x 200



GA802132-BIAN

**LATERALE IN TEXTILENE PER LATO DA 4M PER PERGOLA BIOCLIMATICA ELLE**



Laterale manuale in textilene BIANCO  
cm 383 x 200



GA802132-DGRE

**LATERALE IN TEXTILENE PER LATO DA 4M PER PERGOLA BIOCLIMATICA ELLE**



Laterale manuale in textilene GRIGIO SCURO  
cm 383 x 200





GA802142-DGRE

**PERGOLA BIOCLIMATICA 3x3 EASY**

GRIGIO SCURO



8 057635 315636



m 3 x 3 x 2,5 h  
pali 105 x105 mm

154

1

Struttura in alluminio grigio scuro  
copertura a lamelle frangisole  
in metallo galvanizzato e verniciato  
orientabili a movimentazione manuale  
resistente a tutte le intemperie

GA802143-DGRE

**PERGOLA BIOCLIMATICA 3x4 EASY**

GRIGIO SCURO



8 057635 315643



cm 3 x 4 x 2,5 h  
pali 105 x105 mm

191

1

Struttura in alluminio grigio scuro  
copertura a lamelle frangisole  
in metallo galvanizzato e verniciato  
orientabili a movimentazione manuale  
resistente a tutte le intemperie

GA802144-DGRE

**LATERALE IN TEXTILENE PER LATO DA 3M PERGOLA BIOCLIMATICA EASY**

Laterale manuale in textilene ANTRACITE 300gr/m  
cm 268 x 6 x 234 h



8 057635 315650



GA802145-DGRE

**LATERALE IN TEXTILENE PER LATO DA 4M PER PERGOLA BIOCLIMATICA EASY**

Laterale manuale in textilene ANTRACITE 300gr/m  
cm 368 x 6 x 234 h



8 057635 315667





GA802153-BIAN

**PERGOLA BIOCLIMATICA 3 X 3 EASY CON DOPPIA LAMELLA**

BIANCO



8 057635 317968



m 3 x 3 x 2,5 h  
pali 105 x105 mm

124

1

Struttura in alluminio verniciato bianco  
copertura a doppie lamelle frangisole in alluminio  
orientabili a movimentazione manuale  
resistente a tutte le intemperie



GA802152-BIAN

**PERGOLA BIOCLIMATICA 4 X 4 EASY CON DOPPIA LAMELLA**

BIANCO



8 057635 317944



m 4 x 4 x 2,5 h  
pali 105x105mm

193

1

Struttura in alluminio verniciato bianco  
copertura a doppie lamelle frangisole in alluminio  
orientabili a movimentazione manuale  
resistente a tutte le intemperie



GA802153-DGRE

**PERGOLA BIOCLIMATICA 3 X 3 EASY CON DOPPIA LAMELLA**

GRIGIO SCURO



8 057635 317975



m 3 x 3 x 2,5 h  
pali 105 x105 mm

124

1

Struttura in alluminio verniciato grigio scuro  
copertura a doppie lamelle frangisole in alluminio  
orientabili a movimentazione manuale  
resistente a tutte le intemperie



GA802152-DGRE

**PERGOLA BIOCLIMATICA 4 X 4 EASY CON DOPPIA LAMELLA**

GRIGIO SCURO



8 057635 317951



cm 4 x 4 x 2,5 h  
pali 105x105mm

193

1

Struttura in alluminio verniciato grigio scuro  
copertura a doppie lamelle frangisole in alluminio  
orientabili a movimentazione manuale  
resistente a tutte le intemperie





GA802154-BIAN

**PERGOLA BIOCLIMATICA 3 X 4 EASY CON DOPPIA LAMELLA**

BIANCO



8 057635 317982



m 3 x 4 x 2,5 h  
pali 105x105mm

150

1

Struttura in alluminio verniciato bianco  
copertura a doppie lamelle frangisole in alluminio  
orientabili a movimentazione manuale  
resistente a tutte le intemperie



GA802154-DGRE

**PERGOLA BIOCLIMATICA 3 X 4 EASY CON DOPPIA LAMELLA**

GRIGIO SCURO



8 057635 317999



cm 3 x 4 x 2,5 h  
pali 105x105mm

150

1

Struttura in alluminio verniciato grigio scuro  
copertura a doppie lamelle frangisole in alluminio  
orientabili a movimentazione manuale  
resistente a tutte le intemperie



GA802144-DGRE



8 057635 315650

**LATERALE IN TEXTILENE PER LATO DA 3M PERGOLA BIOCLIMATICA EASY E PERGOLA BIOCLIMATICA EASY DOPPIA LAMELLA**

Laterale manuale in textilene ANTRACITE 300gr/m  
cm 268 x 6 x 234 h



GA802144-BIAN



8 057635 319351

**LATERALE IN TEXTILENE PER LATO DA 3M PERGOLA BIOCLIMATICA EASY DOPPIA LAMELLA**

Laterale manuale in textilene 300g BIANCO  
cm 268 x 6 x 234 h



GA802156-DGRE



8 057635 319375

**LATERALE IN TEXTILENE PER LATO DA 4M PERGOLA BIOCLIMATICA EASY DOPPIA LAMELLA**

Laterale manuale in textilene ANTRACITE 300gr/m



GA802156-BIAN



8 057635 319368

**LATERALE IN TEXTILENE PER LATO DA 4M PERGOLA BIOCLIMATICA EASY DOPPIA LAMELLA**

Laterale manuale in textilene BIANCO 300gr/m





GA802155-BIAN

**PERGOLA BIOCLIMATICA 4 X 8 EASY CON DOPPIA LAMELLA**

BIANCO



8 057635 318002



cm 4 x 8 x 2,5 h  
pali 105 x105 mm

350

1

Struttura in alluminio verniciato bianco  
copertura a doppie lamelle frangisole in alluminio  
orientabili a movimentazione manuale  
resistente a tutte le intemperie



GA802155-DGRE

**PERGOLA BIOCLIMATICA 4 X 8 EASY CON DOPPIA LAMELLA**

GRIGIO SCURO



8 057635 318019



cm 4 x 8 x 2,5 h  
pali 105 x105 mm

350

1

Struttura in alluminio verniciato grigio scuro  
copertura a doppie lamelle frangisole in alluminio  
orientabili a movimentazione manuale  
resistente a tutte le intemperie



GA802157-DGRE



8 057635 319399

**LATERALE DA 4 M PER LATO DA 8 M PER PERGOLA BIOCLIMATICA EASY CON DOPPIA LAMELLA**

Laterale manuale in textilene ANTRACITE 300gr/m



GA802157-BIAN



8 057635 319382

**LATERALE DA 4 M PER LATO DA 8 M PER PERGOLA BIOCLIMATICA EASY CON DOPPIA LAMELLA**

Laterale manuale in textilene BIANCO 300gr/m



GA802156-DGRE



8 057635 319375

**LATERALE IN TEXTILENE PER LATO DA 4M PERGOLA BIOCLIMATICA EASY DOPPIA LAMELLA**

Laterale manuale in textilene ANTRACITE 300gr/m



GA802156-BIAN



8 057635 319368

**LATERALE IN TEXTILENE PER LATO DA 4M PERGOLA BIOCLIMATICA EASY DOPPIA LAMELLA**

Laterale manuale in textilene BIANCO 300gr/m





GA802001  
**GAZEBO ASTORIA 3x4**



m3x4   
63   
1

**ACQUISTABILE SEPARATAMENTE**

GA802003  
**TELO DI RICAMBIO ASTORIA 3x4**

m 3x4 / 3 kg / 1pz  
Telo in poliestere BIANCO 180 gr/m<sup>2</sup>

Struttura in metallo, pali in alluminio, verniciato bianco, gambe 100 x 100 mm

Telo in poliestere bianco 180gr/m<sup>2</sup>

GA802028  
**GAZEBO ASTORIA 3x3**

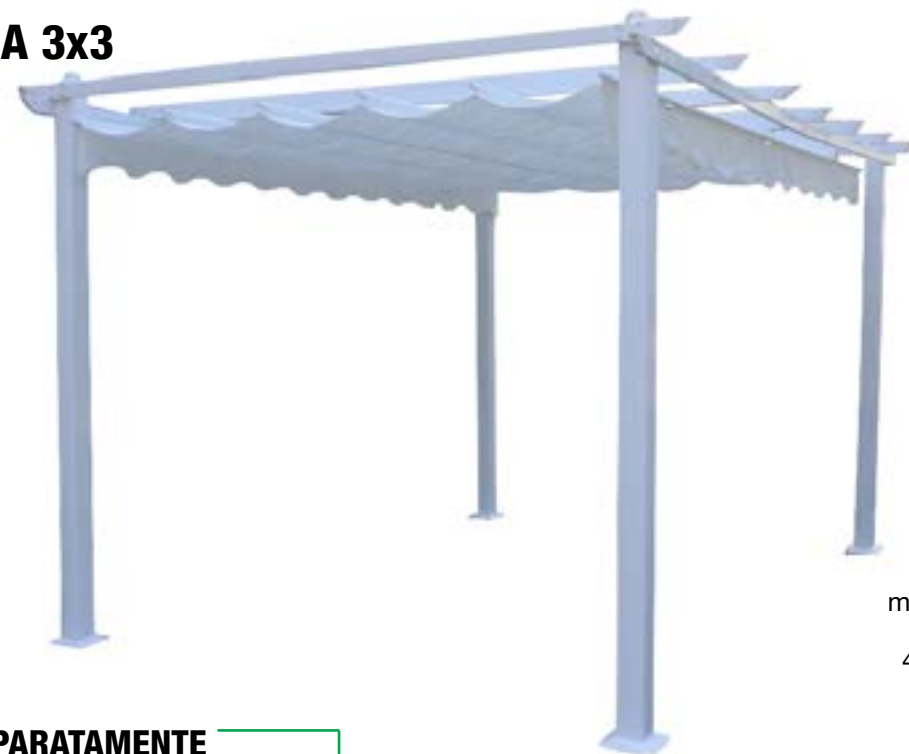

m3x3   
48,5   
1

**ACQUISTABILE SEPARATAMENTE**

GA802029  
**TELO DI RICAMBIO ASTORIA 3x3**

m 3,5 x 3,5 / 2,5 kg / 1pz  
Telo in poliestere BIANCO 180 gr/m<sup>2</sup>

Struttura in metallo, pali in alluminio verniciato bianco, gambe 100 x 100 mm

Telo in poliestere bianco 180gr/m<sup>2</sup>

GA802095  
**GAZEBO ASTORIA 3 X 3**

**TORTORA TELO GRIGIO**



m 3 x 3   
48,5   
1

**ACQUISTABILE SEPARATAMENTE**

GA802097  
**TELO DI RICAMBIO ASTORIA 3x3 GRIGIO**

m 3,5 x 3,5 / 2,5 kg / 1pz  
Telo in poliestere GRIGIO 180 gr/m<sup>2</sup>

Struttura in metallo, pali in alluminio verniciato tortora, gambe 100 x 100 mm

Telo in poliestere grigio 180 gr/m<sup>2</sup>



GA802094

**GAZEBO ASTORIA 3 X 4**

TORTORA TELO GRIGIO

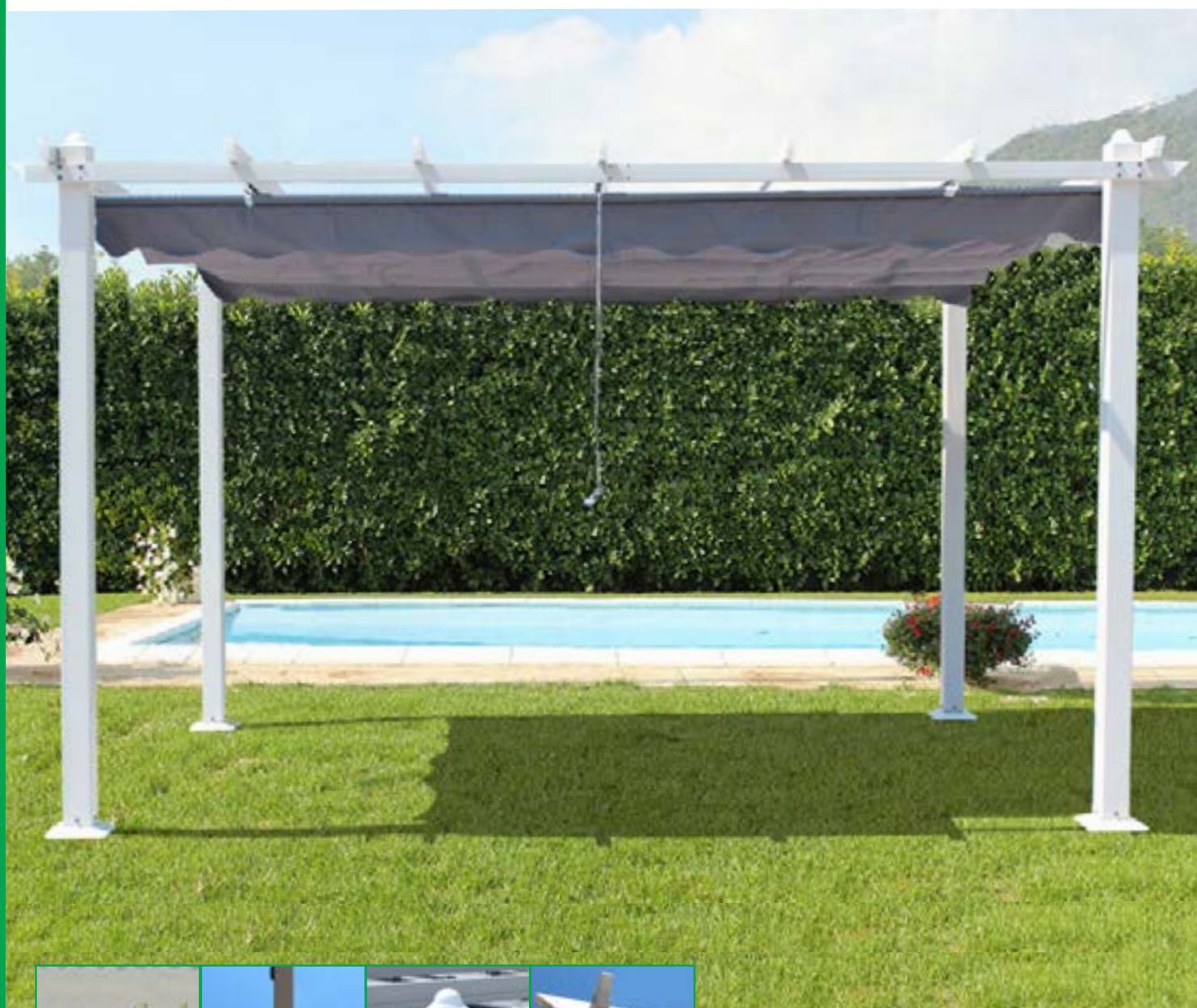

m3x4

63

1

**ACQUISTABILE SEPARATAMENTE**

GA802096

**TELO DI RICAMBIO ASTORIA 3x4 GRIGIO**

m 3x4 / 3 kg / 1pz  
Telo in poliestere GRIGIO 180 gr/m<sup>2</sup>

Struttura in metallo, pali in alluminio verniciato tortora, gambe 100 x 100 mm

Telo in poliestere grigio 180 gr/m<sup>2</sup>

GA802086

**GAZEBO ASTORIA 3 X 4**

ANTRACITE TELO BEIGE



m3x4x2,2h

73

1

**ACQUISTABILE SEPARATAMENTE**

GA802110

**TELO DI RICAMBIO ASTORIA 3x4**

m 3x4 / 3kg / 1pz  
Telo in poliestere AVORIO 180 gr/m<sup>2</sup>

Struttura in metallo, pali in alluminio verniciato antracite, gambe 100 x 100 mm

Telo in poliestere beige 180 gr/m<sup>2</sup>



GA802106

**GAZEBO ALLUNGABILE TUCSON 3x3/6**

ANTRACITE/TELO GRIGIO

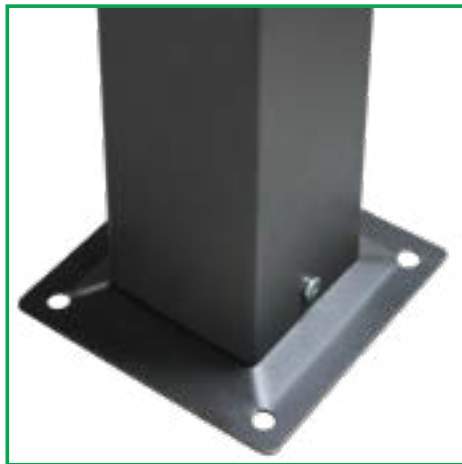
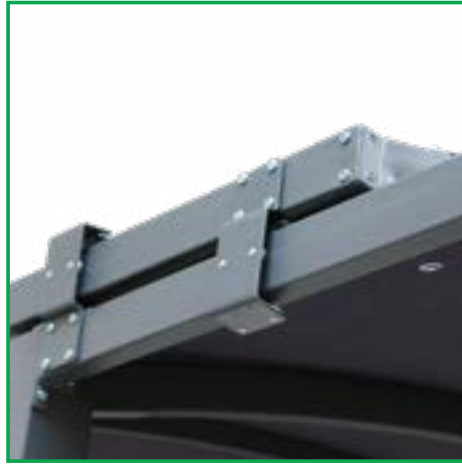

**ACQUISTABILE SEPARATAMENTE**

GA802116

**TELO DI RICAMBIO TUCSON 3X3/6**

m 3x3/6  
Telo in poliestere GRGIO 300 gr/m<sup>2</sup>



m 3/6 x 3

94

1

Doppia struttura in metallo ANTRACITE  
Si può allungare facilmente spostando la struttura superiore tramite le due ruote dotate di sistema di bloccaggio, gambe 80 x 80 mm

Telo in poliestere GRGIO 300 gr/m<sup>2</sup>



GA802038

**GAZEBO KARNAK 3x4**



m3x4x2,6h

54

1

**ACQUISTABILI SEPARATAMENTE**

GA802059

**TELO DI RICAMBIO GAZEBO KARNAK 3x4**

m 3x4  
telo in poliestere BEIGE 200 gr/m<sup>2</sup>

GA802078

**SET PARETI GAZEBO KARNAK 3x4**

laterali in poliestere BEIGE 160 gr/m<sup>2</sup>

Struttura in metallo verniciato antracite  
gambe ø mm70x1,2 - copert. mm 15x15/18x18

Telo e laterali in poliestere beige 200-160gr/m<sup>2</sup>  
Con antivento

GA802021

**GAZEBO AVANA 3x4**



m3x4

39

1

**ACQUISTABILE SEPARATAMENTE**

GA802023

**KIT TELO + 4 LATERALI AVANA 3x4**

m 3x4 / 1pz  
Telo in poliestere 180gr/m<sup>2</sup> e laterali 160gr/m<sup>2</sup>

Struttura in alluminio antracite

Telo in poliestere 180gr/m<sup>2</sup> con doppio tetto  
Completo di 4 tende e zanzariere /  
sistema di chiusura con zip  
Laterali 160gr/m<sup>2</sup>

GA802039

**GAZEBO SIWA 3x3**



m3x3xh2,60

49

1

**ACQUISTABILI SEPARATAMENTE**

GA802058

**TELO DI RICAMBIO GAZEBO SIWA 3x3**

m 3x3  
telo in poliestere BEIGE 200 gr/m<sup>2</sup>

GA802077

**SET PARETI GAZEBO SIWA 3x3**

laterali in poliestere BEIGE 160 gr/m<sup>2</sup>

Struttura in metallo verniciato antracite  
gambe ø mm 70x1,2 - copert. mm15x15/18x15

Telo e laterali in poliestere beige 200-160gr/m<sup>2</sup>  
Con antivento

GA802020

**GAZEBO AVANA 3x3**



m3x3

37

1

**ACQUISTABILE SEPARATAMENTE**

GA802022

**KIT TELO + 4 LATERALI AVANA 3x3**

m 3x3 / 1pz  
Telo in poliestere 180gr/m<sup>2</sup> e laterali 160gr/m<sup>2</sup>

Struttura in alluminio antracite

Telo in poliestere 180gr/m<sup>2</sup> con doppio tetto  
Completo di 4 tende e zanzariere /  
sistema di chiusura con zip  
Laterali 160gr/m<sup>2</sup>



GA802085  
**GAZEBO ANTIGUA 3,3 x 3,3**



m3,3 x 3,3  
36 KG  
1 PZ

**ACQUISTABILE SEPARATAMENTE**

GA802098  
**TELO DI RICAMBIO ANTIGUA 3,3 x 3,3**

m 3,3x3,3  
Telo in poliestere BEIGE 180 gr/m<sup>2</sup>



struttura in metallo ANTRACITE  
gambe 40 x 40 mm con

Telo in poliestere BEIGE 180gr/m<sup>2</sup>  
con antivento e parete apribile

GA802084  
**GAZEBO LEPANTO 3 X 3**



m 3 x 3  
45 KG  
1 PZ

**ACQUISTABILE SEPARATAMENTE**

GA802104  
**TELO DI RICAMBIO LEPANTO 3x3**

m 3x3 / 2,5kg / 1pz  
Telo in poliestere TORTORA 180 gr/m<sup>2</sup>



struttura in metallo ANTRACITE  
gambe 40 x 40 mm

Telo in poliestere tortora 180 gr/m<sup>2</sup>

GA802071  
**GAZEBO HOGAN 3x3**

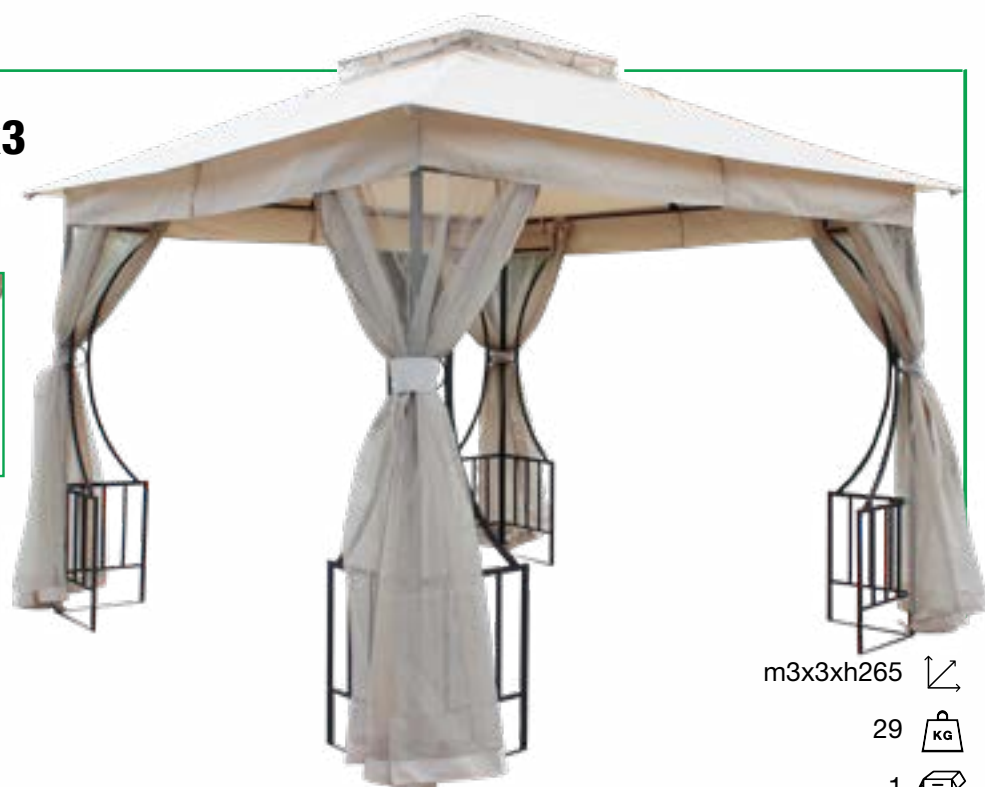

m3x3xh265  
29 KG  
1 PZ

**ACQUISTABILE SEPARATAMENTE**

GA802080  
**TELO DI RICAMBIO GAZEBO HOGAN 3x3**

m 3x3 / 3 kg / 1pz  
Telo in poliestere BEIGE 180 gr/m<sup>2</sup>



Struttura in metallo color nero 14X20 mm  
Tubi 14x20/15x15 mm

Telo in poliestere TORTORA 180gr + zanzariera  
Con doppio tetto

GA802002  
**GAZEBO BOSTON 3x3**



m3x3  
24 KG  
1 PZ

**ACQUISTABILE SEPARATAMENTE**

GA802037  
**TELO DI RICAMBIO BOSTON 3x3**

m 3x3 / 1 pz  
Telo in poliestere 180 gr/m<sup>2</sup>



Struttura in metallo antracite

Telo in poliestere BEIGE 180gr/m<sup>2</sup>  
con doppio tetto



GA802010

**GAZEBO LIBERTY 3x3**



m3x3  
25 KG  
1 PZ

**ACQUISTABILE SEPARATAMENTE**

GA802011-IVRY

**TELO DI RICAMBIO LIBERTY 3x3**

m 3x3 / 1 pz  
Telo in poliestere BEIGE 160 gr/m<sup>2</sup>

Struttura in metallo antracite  
Telo in poliestere BEIGE 160gr/m<sup>2</sup>

GA802066

**GAZEBO PERGOLA 3x2,5**



m3x2,5  
24,5 KG  
1 PZ

**ACQUISTABILE SEPARATAMENTE**

GA802067

**TELO DI RICAMBIO PERGOLA 3x2,5**

m 3 x 2,5 / 1 pz  
Telo in poliestere AVORIO 180 gr/m<sup>2</sup>

Struttura in metallo antracite  
H.max 250 cm / H.min 220 cm  
Telo in poliestere avorio 180gr/m<sup>2</sup>

GA802012

**GAZEBO LIBERTY 3x4**



m3x4  
27 KG  
1 PZ

**ACQUISTABILE SEPARATAMENTE**

GA802013-IVRY

**TELO DI RICAMBIO LIBERTY 3x4**

m 3x4 / 1 pz  
Telo in poliestere BEIGE 160 gr/m<sup>2</sup>

Struttura in metallo antracite  
Telo in poliestere BEIGE 160gr/m<sup>2</sup>

GA802076

**GAZEBO PERGOLA 3x4**

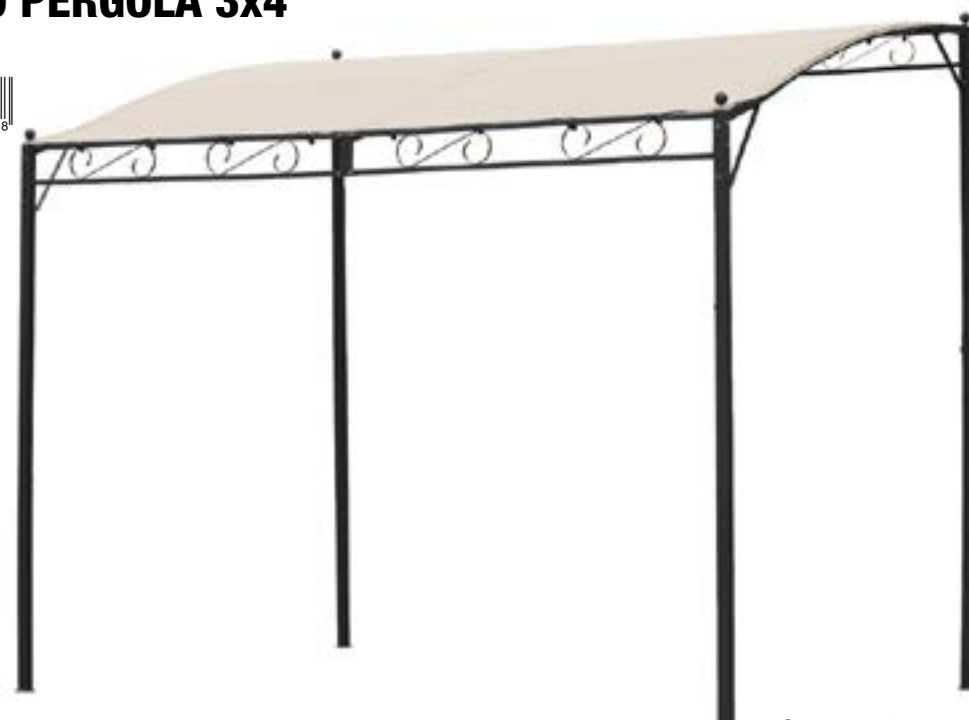

m 3x4  
28 KG  
1 PZ

Struttura in metallo antracite  
H.max 250 cm / H.min 220 cm

Telo in poliestere avorio 180gr/m<sup>2</sup>



GA802092

**GAZEBO PERGOLA ADDOSSATO 3,5 X 2,5**



m 3,5 x 2,5

24

1

struttura in metallo ANTRACITE  
gambe 50 x 50 mm

Telo in poliestere AVORIO 180 gr/m2

GA802016

**GAZEBO ARCO 3x4**

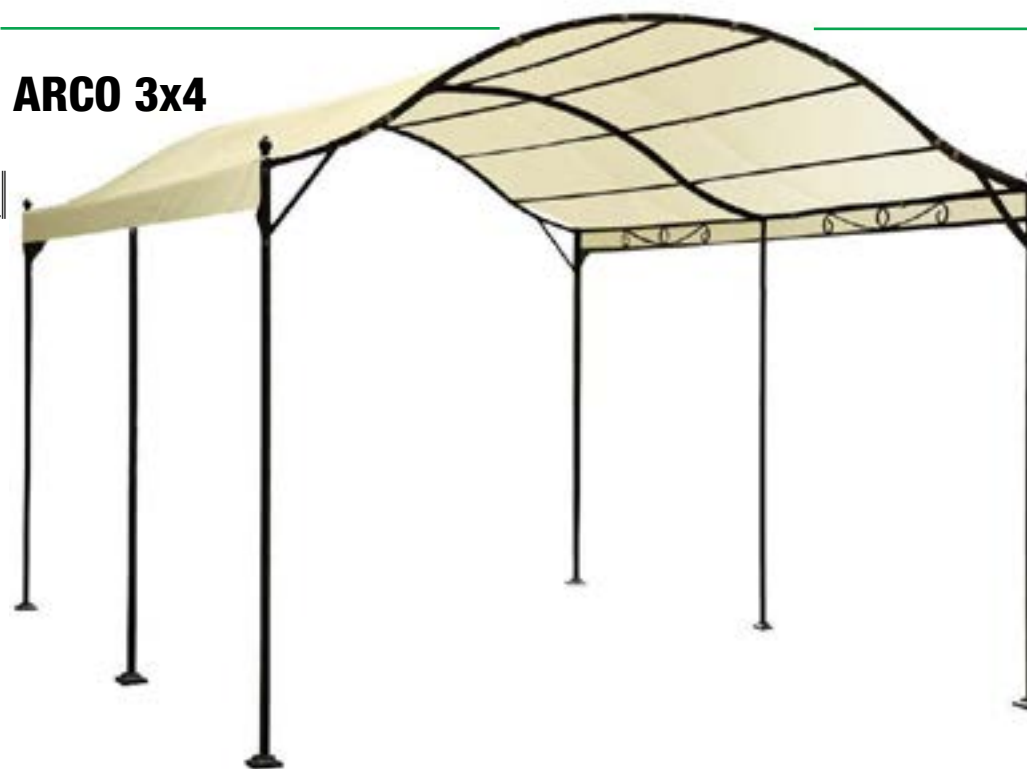

m3x4

36

1

Struttura in metallo antracite

Telo in poliestere avorio 290gr/m<sup>2</sup>

**ACQUISTABILE SEPARATAMENTE**

GA802017

**TELO DI RICAMBIO ARCO 3x4**

m 3x4 / 3,5kg / 1pz  
Telo in poliestere AVORIO 290 gr/m<sup>2</sup>



GA802083

**GAZEBO PERGOLA ADDOSSATO 3 X 4**



m 3 x 4

32

1

struttura in metallo ANTRACITE  
gambe 50 x 50 mm

Telo in poliestere AVORIO 180 gr/m2

**ACQUISTABILE SEPARATAMENTE**

GA802103

**TELO DI RICAMBIO PERGOLA ADDOSSATO 3X4**

m 3x4  
Telo in poliestere AVORIO 180 gr/m<sup>2</sup>



GA802093

**GAZEBO AUTO 3 x 6**



m 3 x 6

32

1

struttura in metallo BIANCA  
gambe Ø 42 mm

Telo in poliestere BIANCO 140 gr/m2

**ACQUISTABILE SEPARATAMENTE**

GA802105

**TELO DI RICAMBIO AUTO 3x6**

m 3x6  
Telo in poliestere BIANCO 140 gr/m<sup>2</sup>





GA802024-IVRY

**GAZEBO PIEGHEVOLE PROFESSIONAL 3x3**



8 033695 767011



**ACQUISTABILI SEPARATAMENTE**

GA802025

**TELO DI RICAMBIO PROFESSIONAL 3x3**



8 033695 767028

m 3x3  
Telo in poliestere 300D BIANCO 270 gr/m<sup>2</sup>

GA802032

**SET PARETI DI RICAMBIO PROFESSIONAL 3x3**



8 034076 142281

Laterali in poliestere 300D BIANCO 270 gr/m<sup>2</sup>  
set composto da 1 parete con porta + 2 pareti con finestra  
+ 1 parete cieca

m3x3  
19   
1

Struttura in alluminio  
connet. in nylon sistema ad anello  
pali 30x30 mm croce rinforzo 12x20mm  
Telo in poliestere 300D BIANCO 270gr/m<sup>2</sup>

GA802068

**GAZEBO PANTHEON 3x3**



8 056099 350276



**ACQUISTABILI SEPARATAMENTE**

GA802072

**TELO DI RICAMBIO PANTHEON 3x3**



8 056099 351136

m 3x3  
Tessuto pvc 800 gr/m<sup>2</sup> BIANCO

GA802074

**SET PARETI GAZEBO PANTHEON 3x3**



8 056099 351150

Tessuto pvc 800 gr/m<sup>2</sup> BIANCO

m3x3  
25   
1

Struttura in alluminio esagonale  
Telo in poliestere BIANCO 800 gr/m<sup>2</sup>  
con PVC spalmato all'interno  
con sacca porta gazebo

GA802033-IVRY

**GAZEBO PIEGHEVOLE PROFESSIONAL 3x4,5**



8 034076 142830



**ACQUISTABILI SEPARATAMENTE**

GA802034

**TELO DI RICAMBIO PROFESSIONAL 3x4,5**



8 034076 142847

m 3x4,5  
Telo in poliestere 300D BIANCO 270 gr/m<sup>2</sup>

GA802035

**SET PARETI DI RICAMBIO PROFESSIONAL 3x4,5**



8 034076 142854

Laterali in poliestere 300D BIANCO 270 gr/m<sup>2</sup>  
set composto da 1 parete con porta + 2 pareti con finestra  
+ 1 parete cieca

m3x4,5  
19   
1

Struttura in alluminio - connet. in nylon  
sistemato ad anello  
pali 30x30 mm croce rinforzo 12x20 mm  
Telo in poliestere 300D BIANCO 270gr/m<sup>2</sup>

GA802069

**GAZEBO PANTHEON 3x4,5**



8 056772 889215



**ACQUISTABILI SEPARATAMENTE**

GA802073

**TELO DI RICAMBIO PANTHEON 3x4,5**



8 056099 351129

m 3x4,5  
Tessuto pvc 800 gr/m<sup>2</sup> BIANCO

GA802075

**SET PARETI GAZEBO PANTHEON 3x4,5**



8 056099 351167

Tessuto pvc 800 gr/m<sup>2</sup> BIANCO

m3x4,5  
29   
1

Struttura in alluminio esagonale  
Telo in poliestere BIANCO 800 gr/m<sup>2</sup>  
con PVC spalmato all'interno  
con sacca porta gazebo



GA802057-IVRY  
**GAZEBO HOLIDAY 3x3**



**ACQUISTABILI SEPARATAMENTE**

GA802061-IVRY

**TELO DI RICAMBIO HOLIDAY 3x3**

m 3x3  
Telo in poliestere BIANCO 420D

GA802062-IVRY

**SET PARETI DI RICAMBIO HOLIDAY 3x3**

Telo e laterali in poliestere BIANCO 210D  
set composto da 1 parete con porta  
+ 1 parete con finestra + 2 pareti cieche

m3x3

22

1

Struttura in metallo

Telo in poliestere BIANCO 420gr/m<sup>2</sup>

GA802060-IVRY  
**GAZEBO HOLIDAY 3x4,5**



**ACQUISTABILI SEPARATAMENTE**

GA802063-IVRY

**TELO DI RICAMBIO HOLIDAY 3x4,5**

m 3x4,5  
Telo in poliestere BIANCO 420D

GA802064-IVRY

**SET PARETI DI RICAMBIO HOLIDAY 3x4,5**

Telo e laterali in poliestere BIANCO 210D  
set composto da 1 parete con porta  
+ 1 parete con finestra + 2 pareti cieche

m3x3

22

1

Struttura in metallo

Telo in poliestere BIANCO 420gr/m<sup>2</sup>

GA802057-VRD  
**GAZEBO HOLIDAY 3x3**



**ACQUISTABILI SEPARATAMENTE**

GA802061-VRD

**TELO DI RICAMBIO HOLIDAY 3x3**

m 3x3  
Telo in poliestere VERDE 420D

GA802062-VRD

**SET PARETI DI RICAMBIO HOLIDAY 3x3**

Telo e laterali in poliestere VERDE 210D  
set composto da 1 parete con porta  
+ 1 parete con finestra + 2 pareti cieche

m3x4,5

27

1

Struttura in metallo

Telo in poliestere VERDE 420D

GA802060-VRD  
**GAZEBO HOLIDAY 3x4,5**



**ACQUISTABILI SEPARATAMENTE**

GA802063-VRD

**TELO DI RICAMBIO HOLIDAY 3x4,5**

m 3x4,5  
Telo in poliestere VERDE 420D

GA802064-VRD

**SET PARETI DI RICAMBIO HOLIDAY 3x4,5**

Telo e laterali in poliestere VERDE 210D  
set composto da 1 parete con porta  
+ 1 parete con finestra + 2 pareti cieche

m3x4,5

27

1

Struttura in metallo

Telo in poliestere VERDE 420D



GA802079-IVRY

**GAZEBO PIEGHEVOLE PARTY 3 X 4,5**



8 052783 701010



m 3 x 4,5 ↗  
22 KG  
1 PZ

Struttura in metallo connettori in poliestere sistema ad anello pali 30x30

Telo in poliestere BIANCO 420D



GA802049

**GAZEBO PIEGHEVOLE PARTY 3x3**



8 034076 149006



m3x3 ↗  
22 KG  
1 PZ

Struttura in metallo connettori in poliestere sistema ad anello pali 30x30

Telo in poliestere BIANCO 420D

GA802079-VRD

**GAZEBO PIEGHEVOLE PARTY 3 X 4,5**



8 052783 701027



m 3 x 4,5 ↗  
22 KG  
1 PZ

Struttura in metallo connettori in poliestere sistema ad anello pali 30x30

Telo in poliestere VERDE 420D



GA802018-IVRY

**GAZEBO PIEGHEVOLE 3x3**



8 033695 762900



m3x3 ↗  
13 KG  
1 PZ

Struttura in metallo pieghevole

Telo in poliestere AVORIO 160gr/m<sup>2</sup>



GA802018-VRD

**GAZEBO PIEGHEVOLE 3x3**



m3x3  
13 KG  
1 PZ

Struttura in metallo pieghevole  
Telo in poliestere VERDE 160gr/m<sup>2</sup>

GA802056

**GAZEBO ECO 3x3**



m3x3  
5,5 KG  
1 PZ

Struttura in metallo  
Telo in raffia bianco

GA802018-BLU

**GAZEBO PIEGHEVOLE 3x3**



m3x3  
13 KG  
1 PZ

Struttura in metallo pieghevole  
Telo in poliestere BLU 160gr/m<sup>2</sup>

GA802055

**GAZEBO ECO 2x3**



m2x3  
5 KG  
1 PZ

Struttura in metallo  
Telo in raffia bianco



OM807249

## OMBRELLONE ZEUS 4 X 4

NERO, TELO GRIGIO

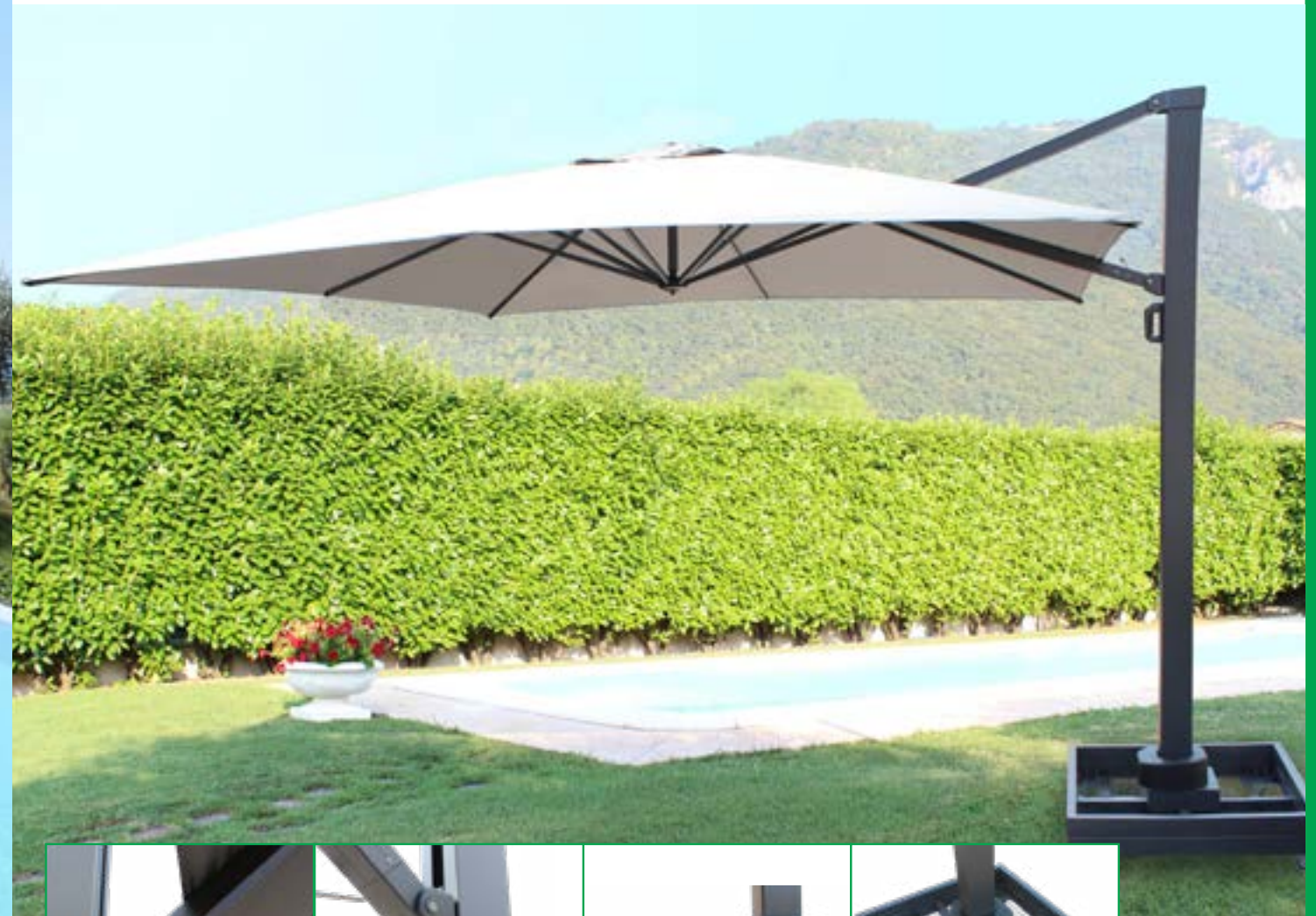
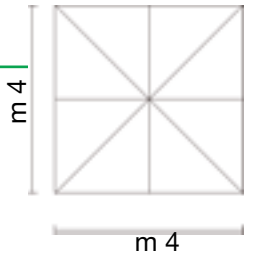

# Ombrelloni

### ACQUISTABILI SEPARATAMENTE

OM807278

#### TELO DI RICAMBIO OMBRELLONE ZEUS

m 4x4  
telo in poliestere 200gr/m<sup>2</sup> con antivento

OM807216

#### LED PER OMBRELLONE

luce a LED con telecomando con altoparlante bluetooth per riprodurre musica, con caricatore USB

m 4x4

110

1

pali in alluminio 100x140x3,2 e 83x93x3,5  
8 stecche 20x40x1,2 mm  
base con ruote cm 100x100x15h

Telo in poliestere grigio scuro  
200 gr/m<sup>2</sup> con antivento





OM807220

**OMBRELLONE DOPPIO 3x3 ARCHIMEDE**

BIANCO, TELO BIANCO



8 058265 844961

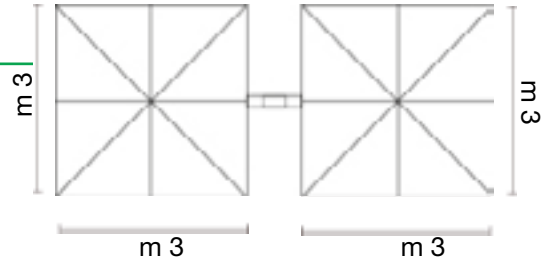

OM807221

**OMBRELLONE DOPPIO 3x3 ARCHIMEDE**

ANTRACITE, TELO TAUPE



8 058265 844978

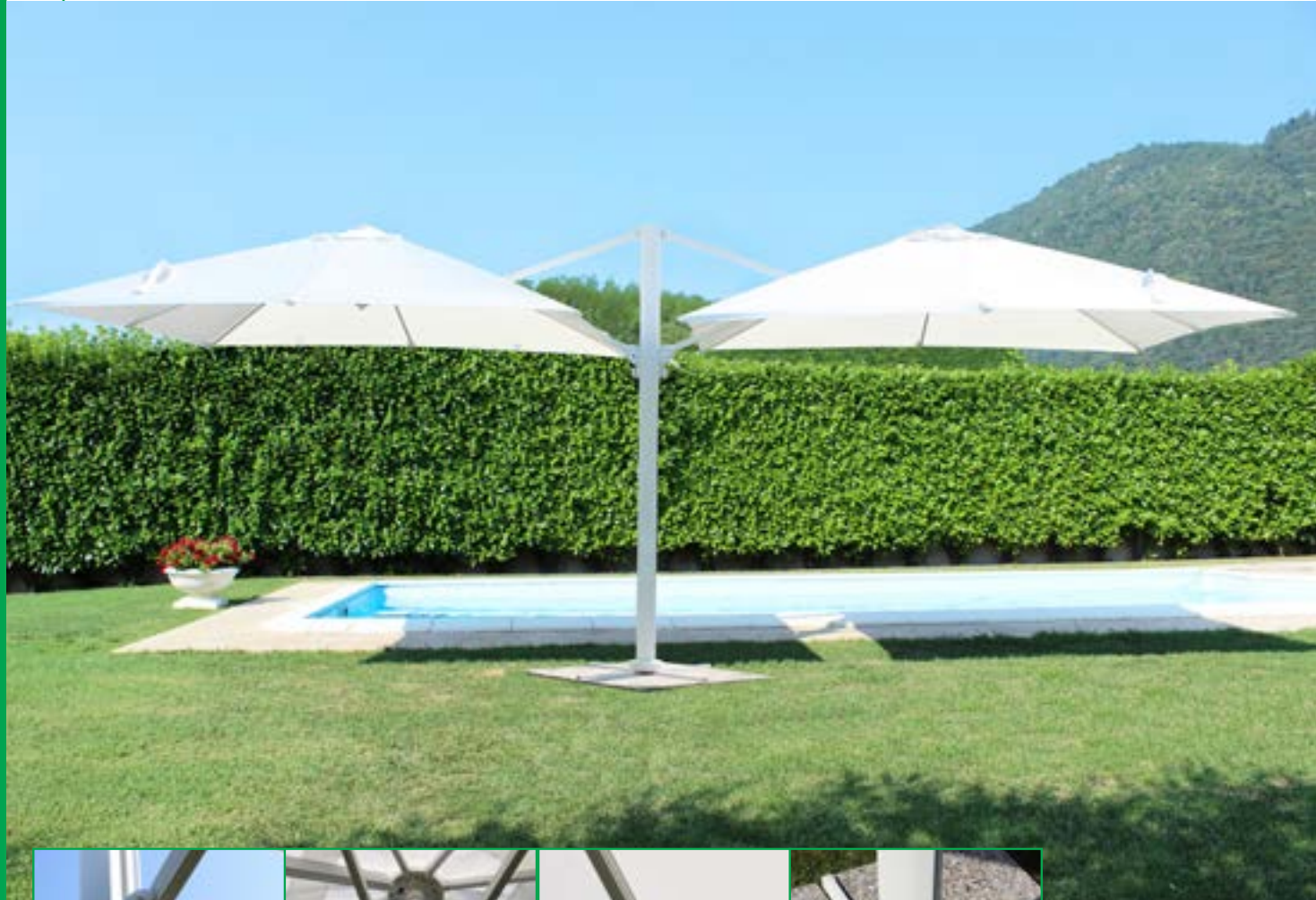
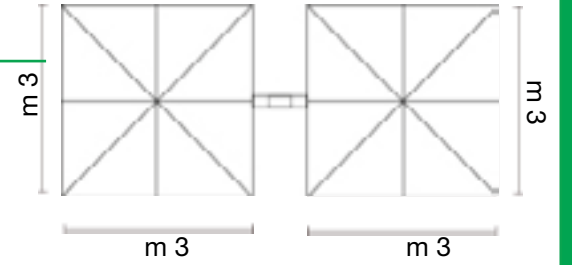

**ACQUISTABILI SEPARATAMENTE**

OM806072

**TELO DI RICAMBIO SATURNO/ARCHIMEDE**

m 3x3  
telo in poliestere BIANCO 250gr/m<sup>2</sup>



OM807216

**LED PER OMBRELLONE**

luce a LED con telecomando con altoparlante bluetooth per riprodurre musica, con caricatore USB



OM807274

**MANIGLIONE DI RICAMBIO ARCHIMEDE BIANCO**



8 051811 408031

m 3x3 e 3x3

44

1

palo in alluminio 80x110mm, 25x40mm  
8 stecche in alluminio 14 x 24mm  
base a crociera

Telo in poliestere 250 gr/m<sup>2</sup>  
con antivento

**ACQUISTABILI SEPARATAMENTE**

OM807126

**TELO DI RICAMBIO SATURNO/ARCHIMEDE**

m 3x3  
telo in poliestere TAUPE 250gr/m<sup>2</sup> con antivento



OM807216

**LED PER OMBRELLONE**

luce a LED con telecomando con altoparlante bluetooth per riprodurre musica, con caricatore USB



OM807275

**MANIGLIONE DI RICAMBIO ARCHIMEDE TAUPE**



8 051811 408048

m 3x3 e 3x3

44

1

palo in alluminio 80x110mm, 25x40mm  
8 stecche in alluminio 14 x 24 mm  
base a crociera

Telo in poliestere 250 gr/m<sup>2</sup>  
con antivento



OM807025

**OMBRELLONE VENERE DELUXE P/L 3x3**

**BIANCO**

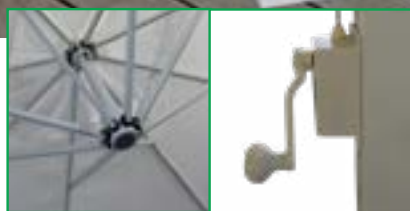
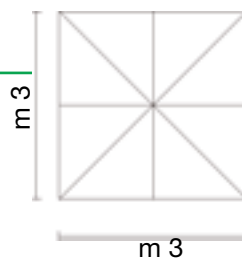

m 3x3  
63,3  
1

**ACQUISTABILE SEPARATAMENTE**

OM807201

**TELO DI RICAMBIO VENERE DELUXE 3x3**

m 3x3  
telo in poliestere BIANCO 270gr/m<sup>2</sup>

Palo in alluminio verniciato bianco 93x93 mm (2pz)  
8 stecche alluminio 20x30 mm intercambiabili

Telo in poliestere beige 300gr/m<sup>2</sup>  
con antivento

OM807011

**OMBRELLONE VENERE DELUXE P/L 3x3**

**NERO**

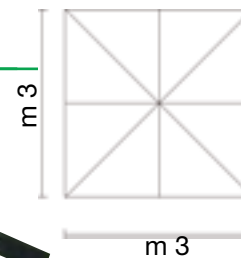

m 3x3  
60,7  
1

**ACQUISTABILE SEPARATAMENTE**

OM807075

**TELO DI RICAMBIO VENERE ALLU. 3x3**

m 3x3  
telo in poliestere BEIGE 270gr/m<sup>2</sup>

Palo in alluminio verniciato  
nero 93 mm x 93mm (2pz)  
8 stecche in alluminio 20x30 mm

Telo in poliestere beige 300gr/m<sup>2</sup>  
con mantovana e antivento

OM807026

**OMBRELLONE VENERE DELUXE P/L 3x4**

**BIANCO**

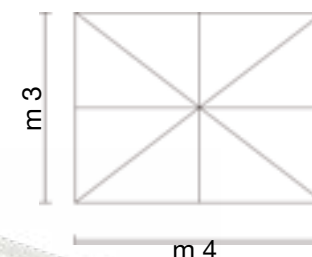
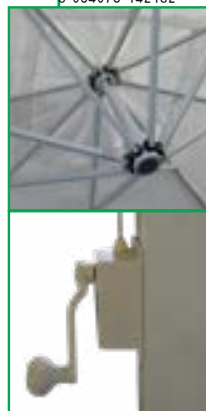

m 3x4  
63,3  
1

**ACQUISTABILE SEPARATAMENTE**

OM807202

**TELO DI RICAMBIO VENERE ALLU. 3x4**

m 3x4  
telo in poliestere BIANCO 270gr/m<sup>2</sup>

Palo in alluminio verniciato bianco 93x93 mm (2pz)  
8 stecche in alluminio 20x30 mm intercambiabili

Telo in poliestere bianco 300gr/m<sup>2</sup>  
con antivento



OM807012

**OMBRELLONE VENERE DELUXE P/L 3x4**

NERO

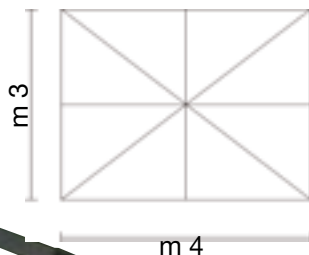

m 3x4  
63,3 kg  
1 pz

Palo in alluminio verniciato nero 93x93 mm (2pz)  
8 stecche alluminio 20x30 mm  
Telo in poliestere beige 300gr/m<sup>2</sup> con mantovana e antivento

**ACQUISTABILE SEPARATAMENTE**

OM807076

**TELO DI RICAMBIO VENERE ALLU. 3x4**

m 3x4  
telo in poliestere BEIGE 270gr/m<sup>2</sup>



OM807010

**OMBRELLONE VENERE P/L 3x4**

TELO BEIGE

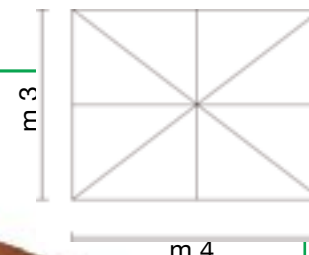

m 3x4, rotante 360°  
73,5 kg  
1 pz

Palo in legno 93 x 93 mm (2pz)  
8 stecche in legno 20x35 mm  
parti metalliche in acciaio inox  
Telo in poliestere beige 270gr/m<sup>2</sup> con mantovana e antivento

**ACQUISTABILI SEPARATAMENTE**

OM807074

**TELO DI RICAMBIO VENERE 3x4**

m 3x4  
telo in poliestere BEIGE 270 gr/m<sup>2</sup>



OM807072

**CARRUCOLA DI RICAMBIO**

carrucola di ricambio per ombrellone legno palo laterale



OM807009

**OMBRELLONE VENERE P/L 3x3**

TELO BEIGE

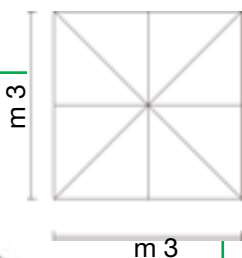

m 3x3, rotante 360°  
71,5 kg  
1 pz

Palo in legno 93 x 93 mm (2pz)  
8 stecche in legno 20x35 mm  
parti metalliche in acciaio inox  
Telo in poliestere beige 270gr/m<sup>2</sup> con mantovana e antivento

**ACQUISTABILI SEPARATAMENTE**

OM807073

**TELO DI RICAMBIO VENERE 3x3**

m 3x3  
telo in poliestere BEIGE 270 gr/m<sup>2</sup>



OM807072

**CARRUCOLA DI RICAMBIO**

carrucola di ricambio per ombrellone legno palo laterale



OM807185

**OMBRELLONE PEGASO P/L 3x4**

BIANCO - TELO TORTORA

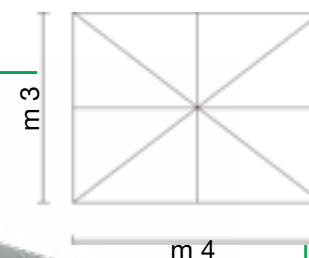

m 3x4  
32 kg  
1 pz

Palo in alluminio 65x65mm BIANCO, noce di abs 115mm con carrucola, 8 stecche in alluminio 17 x 22mm  
Telo in poliestere TORTORA 235 gr/m<sup>2</sup>

**ACQUISTABILI SEPARATAMENTE**

OM807256

**TELO DI RICAMBIO PEGASO 3x4**

m 3x4  
telo in poliestere TORTORA 235 gr/m<sup>2</sup>



OM807257

**CARRUCOLA DI RICAMBIO PEGASO**

carrucola di ricambio per ombrellone alluminio palo laterale





OM807184

**OMBRELLONE PEGASO P/L 3x3**

BIANCO - TELO TORTORA

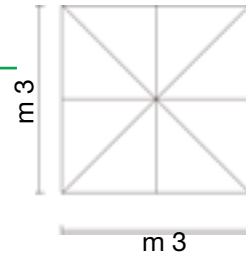

**ACQUISTABILI SEPARATAMENTE**

OM807255

**TELO DI RICAMBIO PEGASO P/L 3 X 3**

m 3x3  
telo in poliestere TORTORA 235 gr/m<sup>2</sup>

OM807257

**CARRUCOLA DI RICAMBIO PEGASO**



Palo in alluminio 65x65 mm color BIANCO  
noce di abs 115mm con carrucola  
8 stecche in alluminio 17 x 22 mm

Telo in poliestere TORTORA 235 gr/m<sup>2</sup>

- m 3x3
- 30 KG
- 1 PZ

OM807312

**OMBRELLONE HAMEL P/L 3x4 GRIGIO**

GRIGIO

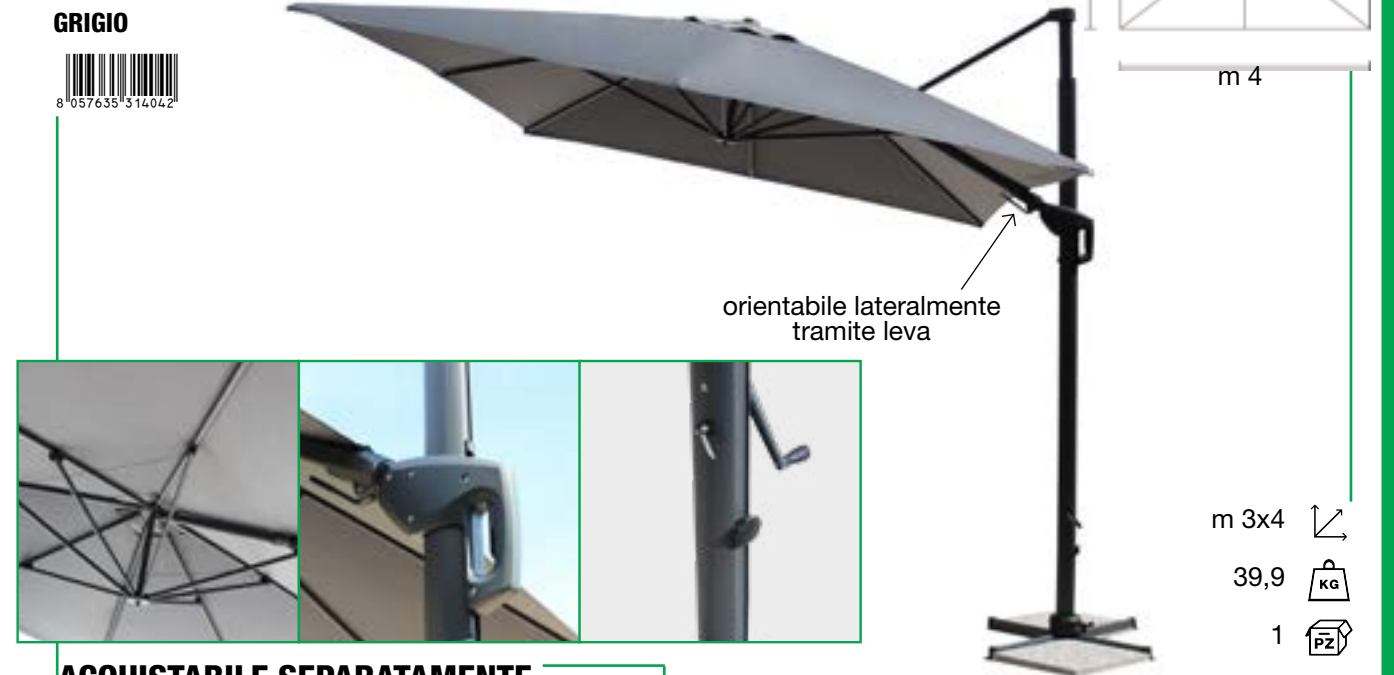
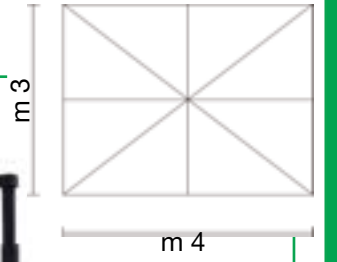

orientabile lateralmente  
tramite leva



**ACQUISTABILE SEPARATAMENTE**

OM807314

**TELO DI RICAMBIO HAMEL 3x4 GRIGIO**

m 3x4  
telo in poliestere grigio 350gr/m<sup>2</sup>



palo in alluminio 55 x 86 x 2,9 mm  
sollevamento assistito con pistone a gas  
leva per orientazione manuale

Telo in poliestere GRIGIO 350 gr/m<sup>2</sup>

- m 3x4
- 39,9 KG
- 1 PZ

OM807313

**OMBRELLONE HAMEL P/L 3x4 BIANCO**

BIANCO

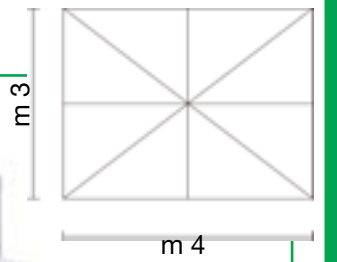

orientabile lateralmente  
tramite leva



**ACQUISTABILE SEPARATAMENTE**

OM807314

**TELO DI RICAMBIO HAMEL 3x4 GRIGIO**

m 3x4  
telo in poliestere grigio 350gr/m<sup>2</sup>



palo in alluminio 55 x 86 x 2,9 mm  
sollevamento assistito con pistone a gas  
leva per orientazione manuale

Telo in poliestere BIANCO 350 gr/m<sup>2</sup>

- m 3x4
- 39,9 KG
- 1 PZ



OM807259

**OMBRELLONE NETTUNO LUX P/L 3x3**

NERO - TELO TAUPE

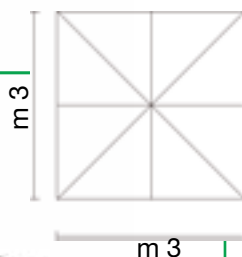

**ACQUISTABILI SEPARATAMENTE**

OM807262

**TELO DI RICAMBIO OMBRELLONE NETTUNO LUX 3x3**

m 3x3  
telo in poliestere TAUPE 250gr/m<sup>2</sup> con antivento



OM807216

**LED PER OMBRELLONE**

luce a LED con telecomando con altoparlante bluetooth per riprodurre musica, con caricatore USB



Palo in alluminio girevole 360°  
95x65 e 48x55mm.  
8 stecche alluminio  
17x25mm, base a crociera  
braccio laterale orientabile

Telo in poliestere taupe 250gr/m<sup>2</sup>  
con antivento

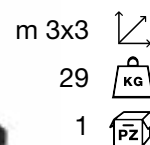

OM807260

**OMBRELLONE NETTUNO LUX P/L 3x3**

NERO - TELO GRIGIO CHIARO

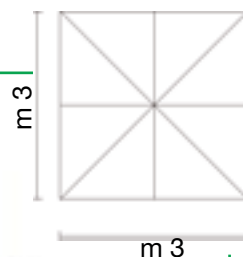

**ACQUISTABILI SEPARATAMENTE**

OM807264

**TELO DI RICAMBIO OMBRELLONE NETTUNO LUX 3x3**

m 3x3  
telo in poliestere GRIGIO CHIARO 250 gr/m<sup>2</sup> con antivento



OM807216

**LED PER OMBRELLONE**

luce a LED con telecomando con altoparlante bluetooth per riprodurre musica, con caricatore USB



Palo in alluminio girevole 360°  
95x65 e 48x55mm.  
8 stecche alluminio  
17x25mm, base a crociera  
braccio laterale orientabile

Telo in poliestere GRIGIO CHIARO  
250gr/m<sup>2</sup> con antivento

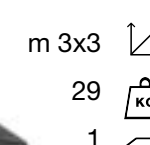

OM807258

**OMBRELLONE NETTUNO LUX P/L 3x4**

NERO - TELO TAUPE

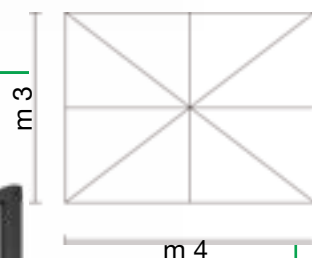

**ACQUISTABILI SEPARATAMENTE**

OM807263

**TELO DI RICAMBIO OMBRELLONE NETTUNO LUX 3x4**

m 3x4  
telo in poliestere TAUPE 250gr/m<sup>2</sup> con antivento



OM807216

**LED PER OMBRELLONE**

luce a LED con telecomando con altoparlante bluetooth per riprodurre musica, con caricatore USB



Palo in alluminio girevole 360°  
95x65 e 48x55mm.  
8 stecche alluminio  
17x25 mm, base a crociera

Telo in poliestere taupe 250gr/m<sup>2</sup>  
con antivento

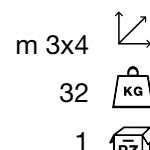

OM807261

**OMBRELLONE NETTUNO LUX P/L 3x4**

NERO - TELO GRIGIO CHIARO

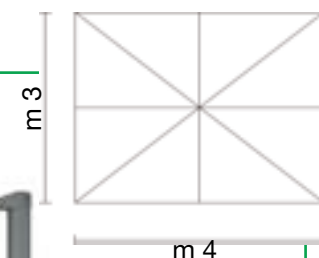

**ACQUISTABILI SEPARATAMENTE**

OM807265

**TELO DI RICAMBIO OMBRELLONE NETTUNO LUX 3x4**

m 3x4  
telo in poliestere GRIGIO CHIARO 250gr/m<sup>2</sup> con antivento



OM807216

**LED PER OMBRELLONE**

luce a LED con telecomando con altoparlante bluetooth per riprodurre musica, con caricatore USB



Palo in alluminio girevole 360°  
95x65 e 48x55mm.  
8 stecche alluminio  
17x25 mm, base a crociera

Telo in poliestere GRIGIO CHIARO  
250gr/m<sup>2</sup> con antivento

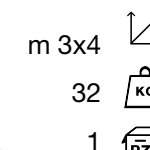



OM807296

**OMBRELLONE MENDEL P/L 3x4**

GRIGIO EFFETTO LEGNO, TELO GRIGIO



8 057635 313694

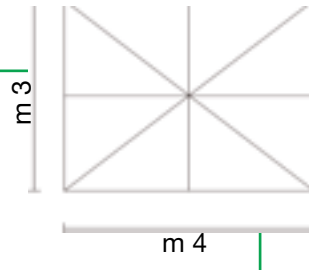

OM807298

**OMBRELLONE MENDEL P/L 3x4**

MARRONE EFFETTO LEGNO, TELO TAUPE



8 057635 314653

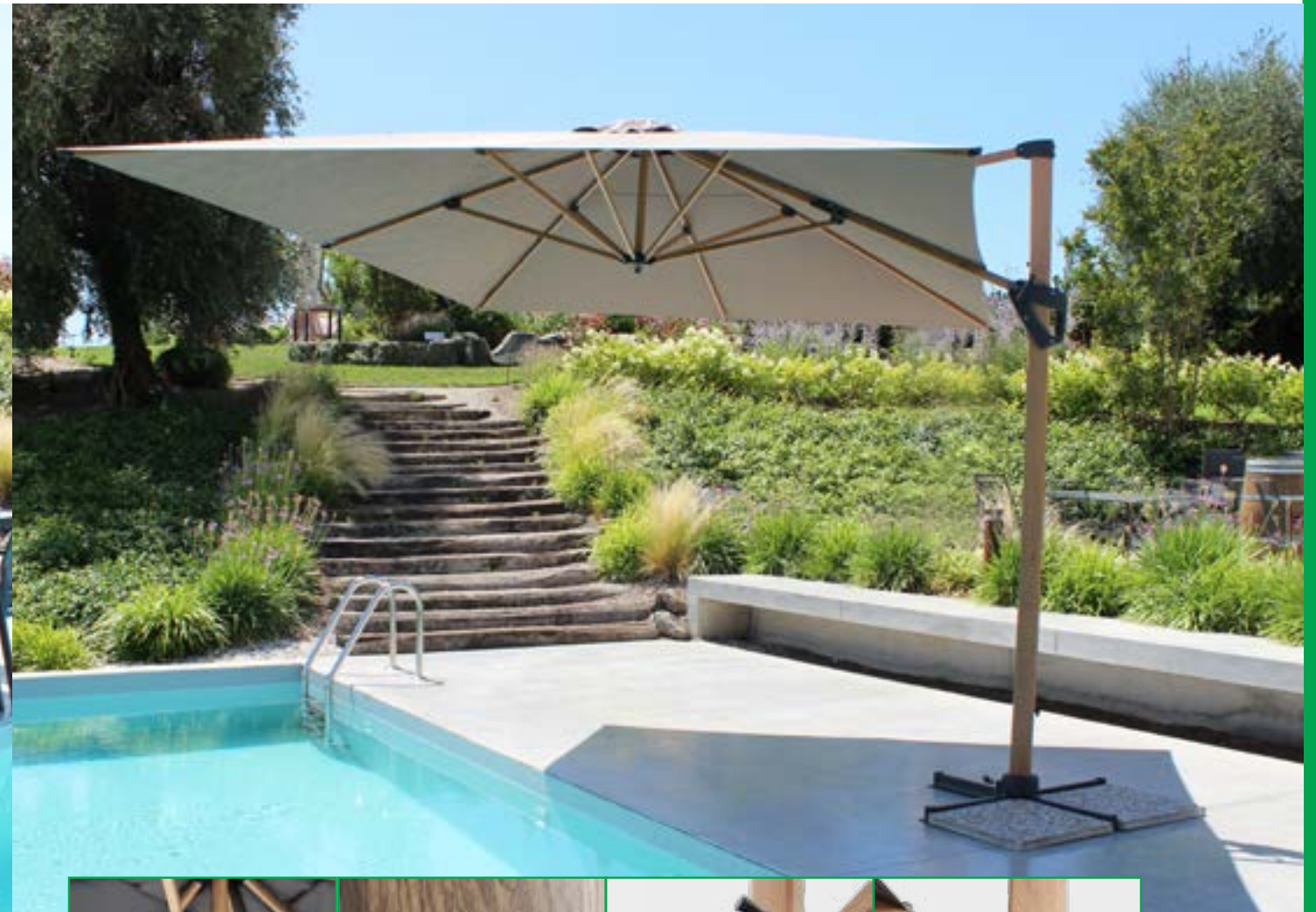
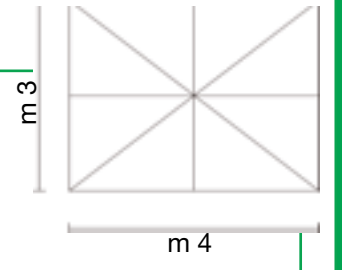

**ACQUISTABILI SEPARATAMENTE**

OM807245

**TELO DI RICAMBIO OMBRELLONE DARWIN/MENDEL**

m 3x4  
telo in poliestere GRIGIO 250gr/m<sup>2</sup> con antivento

OM807216

**LED PER OMBRELLONE**

luce a LED con telecomando con altoparlante bluetooth per riprodurre musica, con caricatore USB

m 3x4

26,5

1



palo girevole in alluminio effetto legno  
55x58 e 40x25 mm  
8 stecche in alluminio 14 x 24 mm  
base a crociera

Telo in poliestere GRIGIO 250 gr/m<sup>2</sup>  
con antivento, piastre in cemento  
acquistabili separatamente

**ACQUISTABILI SEPARATAMENTE**

OM807311

**TELO DI RICAMBIO OMBRELLONE DARWIN/MENDEL**

m 3x4  
telo in poliestere TAUPE 250gr/m<sup>2</sup> con antivento

OM807216

**LED PER OMBRELLONE**

luce a LED con telecomando con altoparlante bluetooth per riprodurre musica, con caricatore USB

m 3x4

26,5

1



palo girevole in alluminio effetto legno  
55x58 e 40x25 mm  
8 stecche in alluminio 14 x 24 mm  
base a crociera

Telo in poliestere TAUPE 250 gr/m<sup>2</sup>  
con antivento, piastre in cemento  
acquistabili separatamente



OM807295

**OMBRELLONE MENDEL P/L 3x3**

GRIGIO EFFETTO LEGNO  
TELO GRIGIO



orientabile lateralmente  
tramite leva

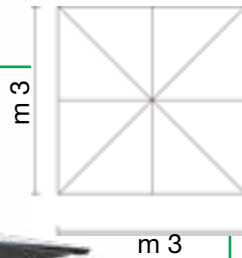

m 3x3  
24,5  
1

☒  
📦  
🔧

palo girevole in alluminio effetto legno  
55x58 e 40x25 mm  
8 stecche in alluminio 14 x 24 mm  
base a crociera  
con leva per orientazione manuale

Telo in poliestere GRIGIO 250 gr/m<sup>2</sup>  
con antivento, piastre in cemento  
acquistabili separatamente

**ACQUISTABILI SEPARATAMENTE**

OM807244

**TELO DI RICAMBIO OMBRELLONE DARWIN/MENDEL**

m 3x3  
telo in poliestere GRIGIO 250gr/m<sup>2</sup> con antivento

OM807216

**LED PER OMBRELLONE**

luce a LED con telecomando con altoparlante bluetooth  
per riprodurre musica, con caricatore USB

OM807219

**OMBRELLONE DARWIN GRIGIO P/L 3x4 GRIGIO**

GRIGIO, TELO GRIGIO

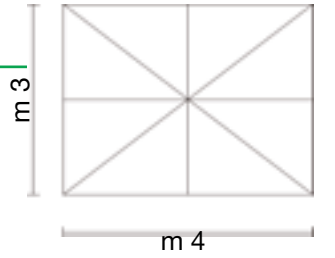

m 3x4  
26,5  
1

☒  
📦  
🔧

palo girevole in alluminio 58x88 e 40x25 mm  
8 stecche alluminio 14x24 mm, base a crociera

Telo in poliestere GRIGIO 250 gr/m<sup>2</sup>  
con antivento

**ACQUISTABILI SEPARATAMENTE**

OM807245

**TELO DI RICAMBIO OMBRELLONE PITAGORA**

m 3x4  
telo in poliestere GRIGIO 250gr/m<sup>2</sup> con antivento

OM807216

**LED PER OMBRELLONE**

luce a LED con telecomando con altoparlante bluetooth  
per riprodurre musica, con caricatore USB

OM807297

**OMBRELLONE MENDEL P/L 3x3**

MARRONE EFFETTO LEGNO  
TELO TAUPE



orientabile lateralmente  
tramite leva

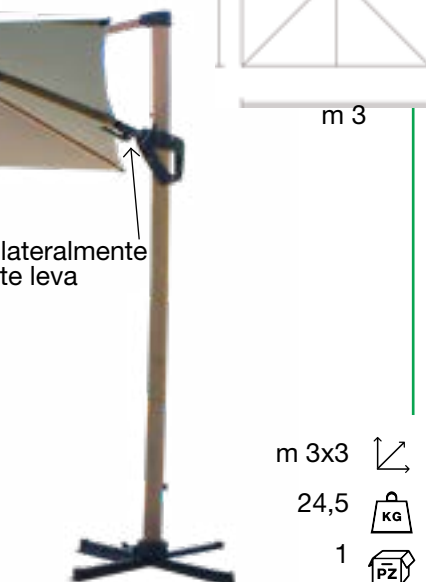
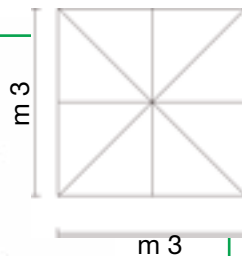

m 3x3  
24,5  
1

☒  
📦  
🔧

palo girevole in alluminio effetto legno  
55x58 e 40x25 mm  
8 stecche alluminio 14 x 24 mm,  
base a crociera  
con leva per orientazione manuale

Telo in poliestere TAUPE 250 gr/m<sup>2</sup>  
con antivento, piastre in cemento  
acquistabili separatamente

**ACQUISTABILI SEPARATAMENTE**

OM807310

**TELO DI RICAMBIO OMBRELLONE DARWIN/MENDEL**

m 3x3  
telo in poliestere TAUPE 250gr/m<sup>2</sup> con antivento

OM807216

**LED PER OMBRELLONE**

luce a LED con telecomando con altoparlante bluetooth  
per riprodurre musica, con caricatore USB



OM807213

**OMBRELLONE DARWIN GRIGIO P/L 3x3**

GRIGIO, TELO GRIGIO



8 058265 843629

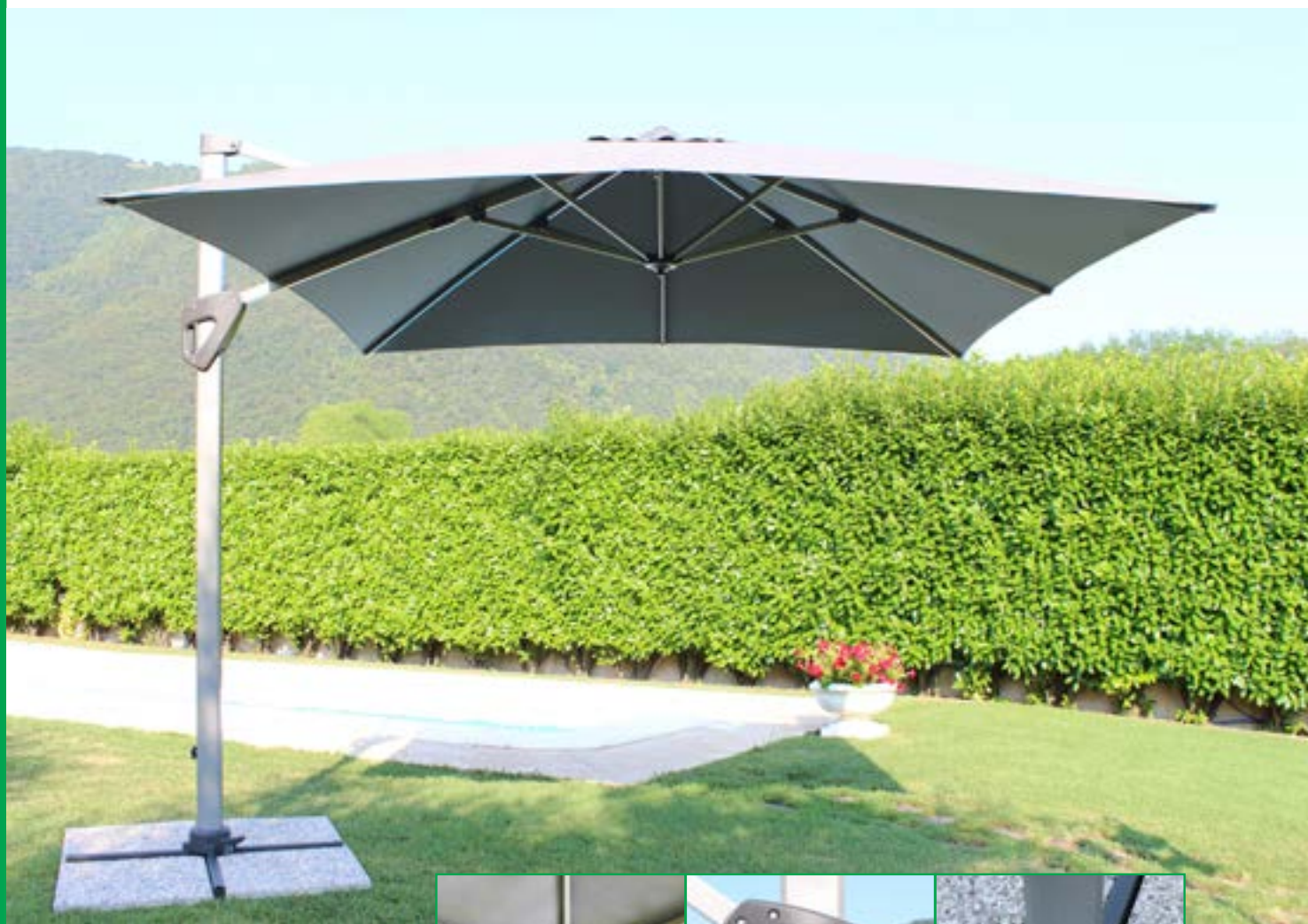
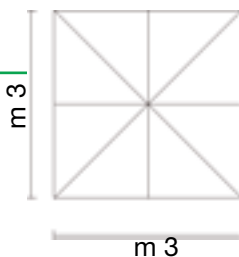

**ACQUISTABILI SEPARATAMENTE**

OM807244

**TELO DI RICAMBIO OMBRELLONE PITAGORA**

m 3x3  
telo in poliestere GRIGIO 250gr/m<sup>2</sup> con antivento

OM807216

**LED PER OMBRELLONE**

luce a LED con telecomando con altoparlante bluetooth per riprodurre musica, con caricatore USB

m 3x3

24,5

1

palo girevole in alluminio 58x88 e 40x25 mm  
8 stecche alluminio 14 x 24 mm  
base a crociera

Telo in poliestere GRIGIO 250 gr/m<sup>2</sup>  
con antivento

OM807284

**OMBRELLONE DARWIN ANTRACITE P/L 3 X 3**

ANTRACITE, TELO ECRU



8 051811 469533

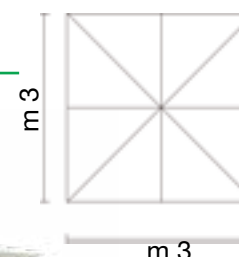

**ACQUISTABILI SEPARATAMENTE**

OM807268

**TELO DI RICAMBIO OMBRELLONE DARWIN**

m 3x3  
telo in poliestere ECRU 250gr/m<sup>2</sup> con antivento

OM807216

**LED PER OMBRELLONE**

luce a LED con telecomando con altoparlante bluetooth per riprodurre musica, con caricatore USB

m 3x3

24,5

1

palo girevole in alluminio 58x88 e 40x25 mm  
8 stecche alluminio 14 x 24 mm  
base a crociera

Telo in poliestere ECRU 250 gr/m<sup>2</sup>  
con antivento

OM807285

**OMBRELLONE DARWIN ANTRACITE P/L 3 X 4**

ANTRACITE, TELO ECRU



8 051811 469540

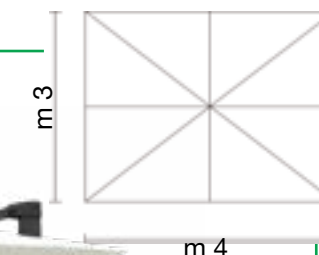

**ACQUISTABILI SEPARATAMENTE**

OM807269

**TELO DI RICAMBIO OMBRELLONE DARWIN**

m 3x4  
telo in poliestere ECRU 250gr/m<sup>2</sup> con antivento

OM807216

**LED PER OMBRELLONE**

luce a LED con telecomando con altoparlante bluetooth per riprodurre musica, con caricatore USB

m 3x4

26,5

1

palo girevole in alluminio 58x88 e 40x25 mm  
8 stecche alluminio 14x24mm, base a crociera

Telo in poliestere ECRU 250 gr/m<sup>2</sup>  
con antivento



OM807222

**OMBRELLONE CON LED 3x3 PITAGORA**

BIANCO, TELO BIANCO



8 058265 844985

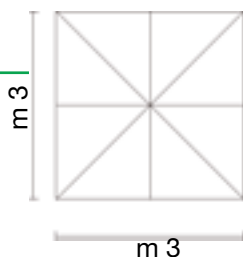

**ACQUISTABILI SEPARATAMENTE**

OM807236

**TELO DI RICAMBIO OMBRELLONE PITAGORA**

m 3x3  
telo in poliestere BIANCO 250gr/m<sup>2</sup> con antivento

OM807279

**MANIGLIONE SATURNO/PITAGORA BIANCO**



8 051811 468086

m 3x3

25

1

palo in alluminio 53x77, 25x42 mm  
8 stecche in alluminio 14 x 24 mm,  
con luci LED, base a crociera

Telo in poliestere BIANCO 250 gr/m<sup>2</sup>  
con antivento

OM807223

**OMBRELLONE CON LED 3x3 PITAGORA**

ANTRACITE, TELO GRIGIO



8 058265 844992

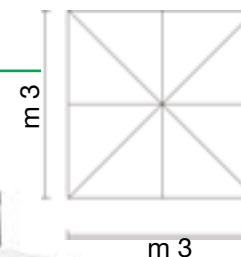

**ACQUISTABILI SEPARATAMENTE**

OM807237

**TELO DI RICAMBIO OMBRELLONE PITAGORA**

m 3x3  
telo in poliestere GRIGIO 250gr/m<sup>2</sup> con antivento

OM807276

**MANIGLIONE SATURNO/PITAGORA ANTRACITE**



8 051811 468055

m 3x3

25

1

palo in alluminio 53 x 77, 25 x 42 mm  
8 stecche in alluminio 14 x 24 mm  
con luci LED, base a crociera

Telo in poliestere GRIGIO 250 gr/m<sup>2</sup>  
con antivento

OM807224

**OMBRELLONE CON LED 3x4 PITAGORA**

BIANCO, TELO BIANCO



8 058265 845005

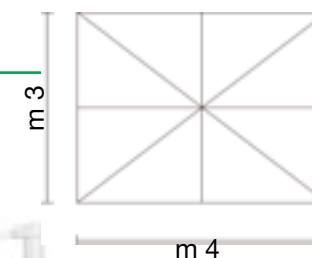

**ACQUISTABILI SEPARATAMENTE**

OM807238

**TELO DI RICAMBIO OMBRELLONE PITAGORA**

m 3x4  
telo in poliestere BIANCO 250gr/m<sup>2</sup> con antivento

OM807283

**MANIGLIONE SATURNO/PITAGORA BIANCO**



8 051811 468125

m 3x4

27

1

palo in alluminio 53 x 77, 25 x 42 mm  
8 stecche in alluminio 14 x 24 mm,  
con luci LED, base a crociera

Telo in poliestere BIANCO 250 gr/m<sup>2</sup>  
con antivento



OM807225

**OMBRELLONE CON LED 3x4 PITAGORA**

ANTRACITE, TELO GRIGIO

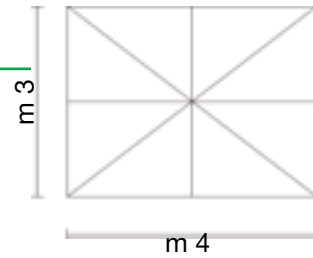

**ACQUISTABILI SEPARATAMENTE**

OM807239

**TELO DI RICAMBIO OMBRELLONE PITAGORA**

m 3x4  
telo in poliestere GRIGIO 250gr/m<sup>2</sup> con antivento

OM807280

**MANIGLIONE SATURNO/PITAGORA NERO**



m 3x4  
27  
1  
palo in alluminio 53 x 77, 25 x 42 mm  
8 stecche in alluminio 14 x 24 mm,  
con luci LED, base a crociera  
Telo in poliestere GRIGIO 250 gr/m<sup>2</sup>  
con antivento

OM807113

**OMBRELLONE SATURNO P/L 3x3**

BIANCO - TELO TORTORA

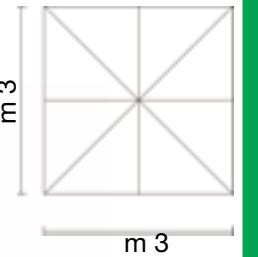

**ACQUISTABILI SEPARATAMENTE**

OM807090

**TELO DI RICAMBIO SATURNO/ARCHIMEDE P/L 3X3**

m 3x3  
telo in poliestere TORTORA 250gr/m<sup>2</sup> con antivento

OM807216

**LED PER OMBRELLONE**

luce a LED con telecomando con altoparlante bluetooth  
per riprodurre musica, con caricatore USB

OM807279

**MANIGLIONE SATURNO/PITAGORA BIANCO**

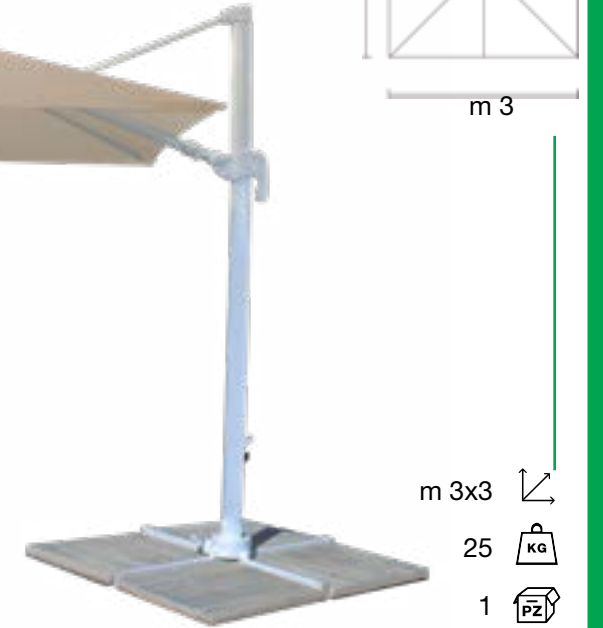

Palo girevole 360°  
in alluminio 53 x 77 e 25 x 40  
8 stecche alluminio 14x24 mm,  
base a crociera

Telo in poliestere tortora 250gr/m<sup>2</sup>  
con antivento

OM807200

**OMBRELLONE SATURNO P/L 3x4**

BIANCO - TELO TORTORA

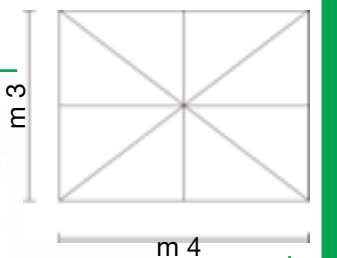

**ACQUISTABILI SEPARATAMENTE**

OM807204

**TELO DI RICAMBIO SATURNO P/L 3X4**

m 3x4  
telo in poliestere TORTORA 250gr/m<sup>2</sup> con antivento

OM807216

**LED PER OMBRELLONE**

luce a LED con telecomando con altoparlante bluetooth  
per riprodurre musica, con caricatore USB

OM807283

**MANIGLIONE SATURNO/PITAGORA BIANCO**

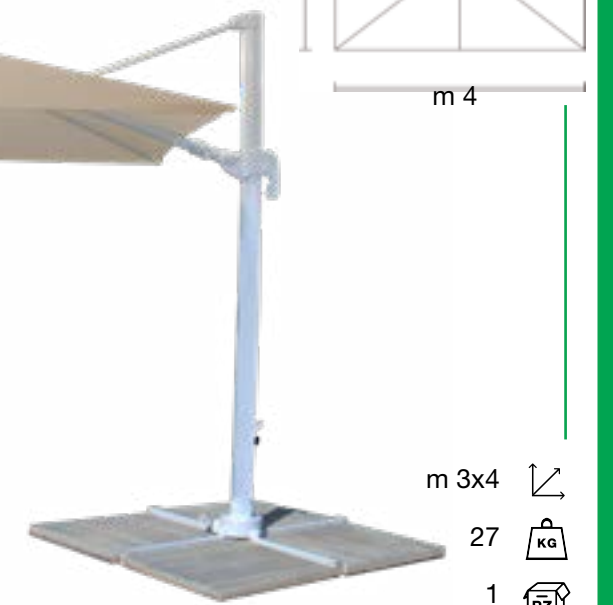

Palo girevole 360°  
in alluminio, 53 x 77 e 25 x 40 mm  
8 stecche alluminio 14x24 mm,  
base a crociera

Telo in poliestere tortora 250gr/m<sup>2</sup>  
con antivento



OM807114  
**OMBRELLONE SATURNO P/L 3x4**  
BIANCO - TELO BIANCO

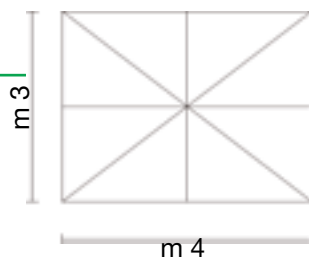

OM806069  
**OMBRELLONE SATURNO P/L 3x3**  
BIANCO - TELO BIANCO

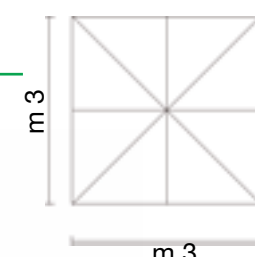

**ACQUISTABILI SEPARATAMENTE**

OM806072  
**TELO DI RICAMBIO SATURNO/ARCHIMEDE P/L 3X3**

m 3x3  
telo in poliestere BIANCO 250gr/m<sup>2</sup>

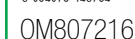

OM807216  
**LED PER OMBRELLONE**

luce a LED con telecomando con altoparlante bluetooth per riprodurre musica, con caricatore USB

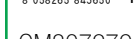

OM807279  
**MANIGLIONE SATURNO/PITAGORA BIANCO**



Palo girevole 360°  
in alluminio 53 x 77 e 25 x 40  
8 stecche alluminio 14 x 24mm,  
base a crociera

Telo in poliestere bianco 250gr/m<sup>2</sup>  
con antivento

OM807198  
**OMBRELLONE SATURNO P/L 3x4**  
TORTORA - TELO TORTORA



**ACQUISTABILI SEPARATAMENTE**

OM807204  
**TELO DI RICAMBIO SATURNO P/L 3 X 4**

m 3x4  
telo in poliestere TORTORA 250gr/m<sup>2</sup>

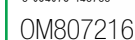

OM807216  
**LED PER OMBRELLONE**

luce a LED con telecomando con altoparlante bluetooth per riprodurre musica, con caricatore USB

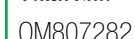

OM807282  
**MANIGLIONE SATURNO TORTORA**



Palo girevole 360°, in alluminio tortora  
53 x 77 e 25 x 40mm  
8 stecche alluminio 14 x 24 mm,  
base a crociera

Telo in poliestere tortora 250gr/m<sup>2</sup>  
con antivento

**ACQUISTABILI SEPARATAMENTE**

OM807203  
**TELO DI RICAMBIO SATURNO BIANCO 3x4**

m 3x4  
telo in poliestere BIANCO 250gr/m<sup>2</sup>



OM807216  
**LED PER OMBRELLONE**

luce a LED con telecomando con altoparlante bluetooth per riprodurre musica, con caricatore USB

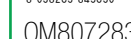

OM807283  
**MANIGLIONE SATURNO/PITAGORA BIANCO**



Palo girevole 360°  
in alluminio 53 x 77 e 25 x 40  
8 stecche alluminio 14 x 24 mm base a crociera

Telo in poliestere bianco 220gr/m<sup>2</sup>  
con antivento



OM806044

**OMBRELLONE SATURNO P/L 3x3**

TORTORA - TELO TORTORA

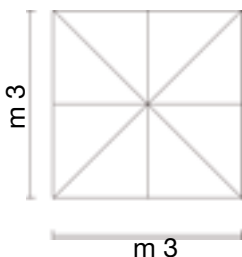

**ACQUISTABILI SEPARATAMENTE**

OM807090

**TELO DI RICAMBIO SATURNO/ARCHIMEDE P/L 3X3**

m 3x3  
telo in poliestere TORTORA 250gr/m<sup>2</sup>

OM807216

**LED PER OMBRELLONE**

luce a LED con telecomando con altoparlante bluetooth per riprodurre musica, con caricatore USB

OM807278

**MANIGLIONE SATURNO TORTORA**



m 3x3  
25 KG  
1 PZ  
Palo girevole 360°  
in alluminio tortora, 53x77 e 25x40mm  
8 stecche alluminio 14x24 mm  
base a crociera  
Telo in poliestere tortora 250gr/m<sup>2</sup>  
con antivento

OM806098

**OMBRELLONE SATURNO P/L 3x3**

TAUPE - TELO TORTORA



**ACQUISTABILI SEPARATAMENTE**

OM807090

**TELO DI RICAMBIO SATURNO/ARCHIMEDE P/L 3X3**

m 3x3  
telo in poliestere TORTORA 250gr/m<sup>2</sup>

OM807216

**LED PER OMBRELLONE**

luce a LED con telecomando con altoparlante bluetooth per riprodurre musica, con caricatore USB

OM807277

**MANIGLIONE SATURNO TAUPE**



OM807199

**OMBRELLONE SATURNO P/L 3x4**

TAUPE - TELO TORTORA



**ACQUISTABILI SEPARATAMENTE**

OM807204

**TELO DI RICAMBIO SATURNO P/L 3 X 4**

m 3x4  
telo in poliestere TORTORA 250gr/m<sup>2</sup>

OM807216

**LED PER OMBRELLONE**

luce a LED con telecomando con altoparlante bluetooth per riprodurre musica, con caricatore USB

OM807281

**MANIGLIONE SATURNO TAUPE**



m 3x4  
27 KG  
1 PZ  
Palo girevole 360° in alluminio taupe,  
53x77 e 25x40mm  
8 stecche alluminio 14x24 mm  
base a crociera  
Telo in poliestere tortora 250gr/m<sup>2</sup>  
con antivento



Palo girevole 360° in alluminio taupe,  
53x77 e 25x40mm  
8 stecche alluminio 14x24 mm  
base a crociera

Telo in poliestere tortora 250gr/m<sup>2</sup>  
con antivento

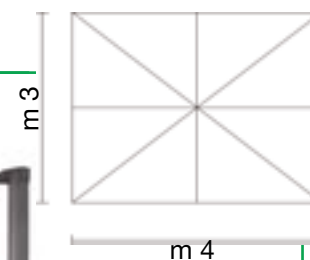

Palo girevole 360° in alluminio taupe,  
53x77 e 25x40mm  
8 stecche alluminio 14x24 mm  
base a crociera

Telo in poliestere tortora 250gr/m<sup>2</sup>  
con antivento



OM806052

**OMBRELLONE SATURNO P/L 3x3**

NERO - TELO ECRU

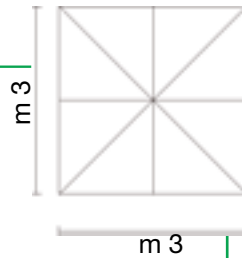

**ACQUISTABILI SEPARATAMENTE**

OM806062

**TELO DI RICAMBIO SATURNO/ARCHIMEDE P/L 3X3**

m 3x3  
telo in poliestere ECRU 250gr/m<sup>2</sup>

OM807216

**LED PER OMBRELLONE**

luce a LED con telecomando con altoparlante bluetooth per riprodurre musica, con caricatore USB

OM807276

**MANIGLIONE SATURNO/PITAGORA ANTRACITE**



m 3x3  
25  
1  
Palo girevole 360°, in alluminio 53x77 e 25x40 mm  
8 stecche alluminio 14x24 mm  
base a crociera  
Telo in poliestere ecrù 250gr/m<sup>2</sup>  
con antivento e mantovane

OM807250

**OMBRELLONE SATURNO P/L 3x3**

ANTRACITE - TELO GRIGIO

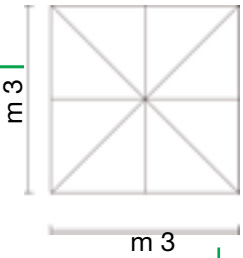

**ACQUISTABILI SEPARATAMENTE**

OM807286

**TELO DI RICAMBIO SATURNO/ARCHIMEDE P/L 3X3**

m 3x3  
telo in poliestere GRIGIO 250gr/m<sup>2</sup>

OM807216

**LED PER OMBRELLONE**

luce a LED con telecomando con altoparlante bluetooth per riprodurre musica, con caricatore USB

OM807276

**MANIGLIONE OMBRELLONE SATURNO/PITAGORA**

NERO

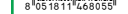

m 3x3  
25  
1  
Palo girevole 360° in alluminio antracite, 53x77 e 25x40mm  
8 stecche alluminio 14x24 mm  
base a crociera  
Telo in poliestere grigio 250gr/m<sup>2</sup>  
con antivento

OM807197

**OMBRELLONE SATURNO P/L 3x4**

NERO - TELO ECRU

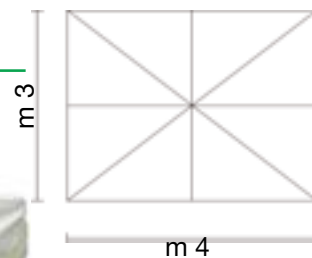

**ACQUISTABILI SEPARATAMENTE**

OM807205

**TELO DI RICAMBIO SATURNO P/L 3x4**

m 3x4  
telo in poliestere ECRU 250gr/m<sup>2</sup>

OM807216

**LED PER OMBRELLONE**

luce a LED con telecomando con altoparlante bluetooth per riprodurre musica, con caricatore USB

OM807280

**MANIGLIONE SATURNO/PITAGORA ANTRACITE**



m 3x4  
27  
1  
Palo girevole 360° in alluminio 53x77 e 25x40 mm  
8 stecche alluminio 14x24 mm  
base a crociera  
Telo in poliestere ecrù 250gr/m<sup>2</sup>  
con antivento e mantovane

OM807251

**OMBRELLONE SATURNO P/L 3x4**

ANTRACITE - TELO GRIGIO

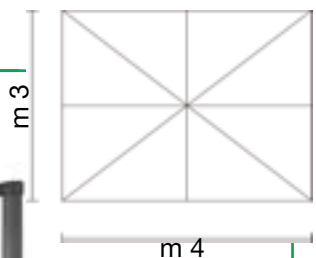

**ACQUISTABILI SEPARATAMENTE**

OM807287

**TELO SATURNO/ARCHIMEDE P/L GRIGIO 3x4**

m 3x4  
telo in poliestere GRIGIO 250gr/m<sup>2</sup>

OM807216

**LED PER OMBRELLONE**

luce a LED con telecomando con altoparlante bluetooth per riprodurre musica, con caricatore USB

OM807276

**MANIGLIONE OMBRELLONE SATURNO/PITAGORA**

NERO



m 3x4  
25  
1  
Palo girevole 360° in alluminio antracite, 53x77 e 25x40mm  
8 stecche alluminio 14x24 mm  
base a crociera  
Telo in poliestere grigio 250gr/m<sup>2</sup>  
con antivento



OM807125  
**OMBRELLONE LIPSI P/L 3x3**  
GRIGIO SCURO

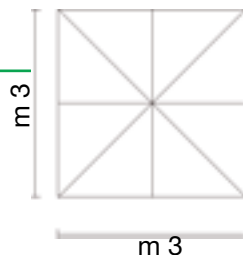

m 3x3  
28   
1

**ACQUISTABILI SEPARATAMENTE**  
OM807254  
**TELO DI RICAMBIO OMBRELLONE LIPSI P/L 3X3**

m 3x3  
telo in poliestere 250gr/m<sup>2</sup> con antivento

Palo in alluminio girevole 360°,  
53x80/25x40mm  
8 stecche metallo 14x24 mm,  
braccio laterale orientabile

Telo in poliestere grigio scuro 250gr/m<sup>2</sup>  
con antivento orientabile lateralmente

OM806091  
**OMBRELLONE MERCURIO P/L 2,5x2,5**  
ECRU

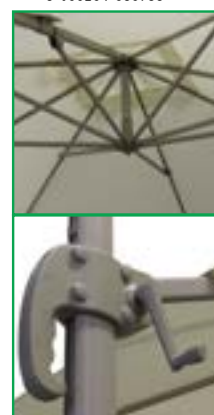
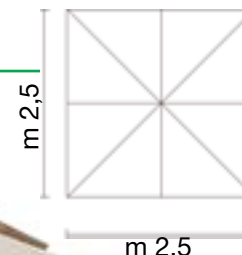

m 2,5x2,5  
19   
1

**ACQUISTABILI SEPARATAMENTE**

OM806105  
**TELO DI RICAMBIO MERCURIO 2,5x2,5**

m 2,5 x 2,5  
telo in poliestere ECRU 200 gr/m<sup>2</sup>

OM807216

**LED PER OMBRELLONE**

luce a LED con telecomando con altoparlante bluetooth  
per riprodurre musica, con caricatore USB

Palo in alluminio 69x53x1,5mm orientabile a 360°  
8 stecche di metallo 12x23x1 mm

Telo in poliestere ecru 200gr/m<sup>2</sup> con antivento

OM806090  
**OMBRELLONE MERCURIO P/L 2x3**  
ECRU

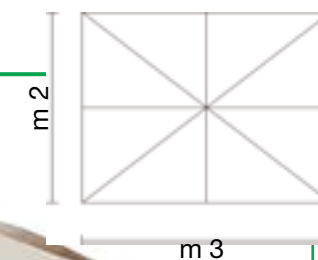

m 2x3  
19   
1

**ACQUISTABILI SEPARATAMENTE**

OM806104  
**TELO DI RICAMBIO MERCURIO 2x3**

m 2x3  
telo in poliestere ECRU 200 gr/m<sup>2</sup>

OM807216

**LED PER OMBRELLONE**

luce a LED con telecomando con altoparlante bluetooth  
per riprodurre musica, con caricatore USB

Palo in alluminio 69x53x1,5 mm orientabile 360°  
8 stecche metallo 12x23x1 mm

Telo in poliestere ecru 200gr/m<sup>2</sup> con antivento



OM806092-GREY

**OMBRELLONE MERCURIO P/L 3x3**

TORTORA - TELO GRIGIO

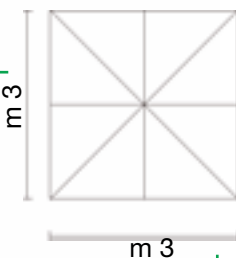

m 3x3  
20   
1

Palo in alluminio tortora 69x53x1,5 mm orientabile 360° con carrucola, 8 stecche metallo 12x23x1 mm

Telo in poliestere grigio 200gr/m<sup>2</sup> con antivento

**ACQUISTABILI SEPARATAMENTE**

OM806106-GREY

**TELO DI RICAMBIO MERCURIO 3x3**

m 3x3  
telo in poliestere GRIGIO 200 gr/m<sup>2</sup>

OM807216

**LED PER OMBRELLONE**

luce a LED con telecomando con altoparlante bluetooth per riprodurre musica, con caricatore USB

OM806092-BEIG

**OMBRELLONE MERCURIO P/L 3x3**

NERO - TELO BEIGE

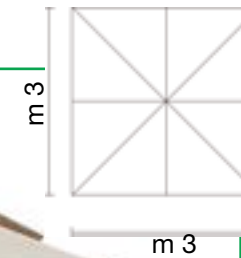
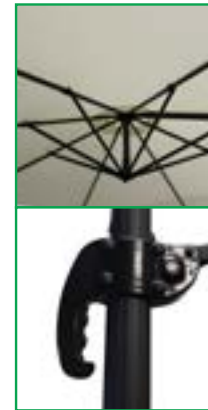

m 3x3  
20   
1

Palo in alluminio 69x53x1,5mm orientabile a 360° 8 stecche di metallo 12x23x1 mm

Telo in poliestere beige 200gr/m<sup>2</sup> con antivento

**ACQUISTABILI SEPARATAMENTE**

OM806106-BEIG

**TELO DI RICAMBIO MERCURIO 3x3**

m 3x3  
telo in poliestere BEIGE 200 gr/m<sup>2</sup>

OM807216

**LED PER OMBRELLONE**

luce a LED con telecomando con altoparlante bluetooth per riprodurre musica, con caricatore USB

OM806093-GREY

**OMBRELLONE MERCURIO P/L 3x4**

TORTORA - TELO GRIGIO

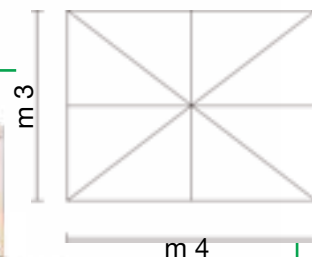

m 3x4  
35   
1

Palo in alluminio tortora 53x80/25x40 mm orientabile 360° con carrucola, 8 stecche metallo 12x23x1 mm

Telo in poliestere grigio 200gr/m<sup>2</sup> con antivento

**ACQUISTABILI SEPARATAMENTE**

OM806107-GREY

**TELO DI RICAMBIO MERCURIO 3x4**

m 3x4  
telo in poliestere GRIGIO 200 gr/m<sup>2</sup>

OM807216

**LED PER OMBRELLONE**

luce a LED con telecomando con altoparlante bluetooth per riprodurre musica, con caricatore USB

OM806093-BEIG

**OMBRELLONE MERCURIO P/L 3x4**

NERO - TELO BEIGE

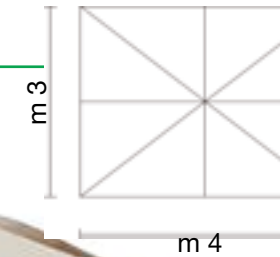
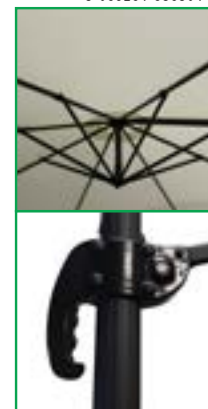

m 3x4  
35   
1

Palo in alluminio 53x80/25x40mm orientabile a 360° 8 stecche di metallo 12x23x1 mm

Telo in poliestere beige 200gr/m<sup>2</sup> con antivento

**ACQUISTABILI SEPARATAMENTE**

OM806107-BEIG

**TELO DI RICAMBIO MERCURIO 3x4**

m 3x4  
telo in poliestere BEIGE 200 gr/m<sup>2</sup>

OM807216

**LED PER OMBRELLONE**

luce a LED con telecomando con altoparlante bluetooth per riprodurre musica, con caricatore USB



OM807214

**OMBRELLONE NEWTON NERO P/L 3x3**

NERO, TELO GRIGIO

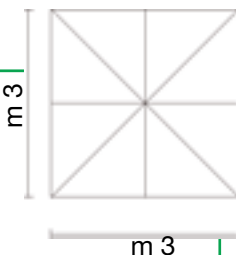

m 3x3

16,7

1



palo girevole a 360° in alluminio 45x64  
e in metallo 20x40 mm  
8 stecche metallo 13 x 22 mm, base a crociera  
Telo in poliestere GRIGIO 180gr/m<sup>2</sup>  
con antivento

**ACQUISTABILI SEPARATAMENTE**

OM807242

**TELO DI RICAMBIO OMBRELLONE NEWTON**

m 3x3  
telo in poliestere GRIGIO 180gr/m<sup>2</sup> con antivento

OM807216

**LED PER OMBRELLONE**

luce a LED con telecomando con altoparlante bluetooth  
per riprodurre musica, con caricatore USB

OM807218

**OMBRELLONE NEWTON NERO P/L 2x3**

NERO, TELO ECRU

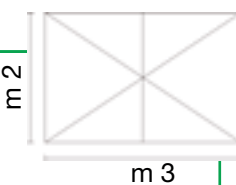
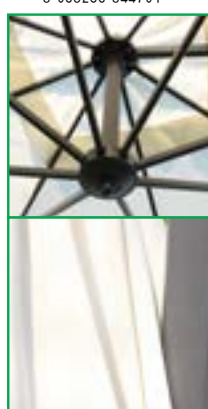

m 2x3

17,5

1



palo girevole a 360° in alluminio 45x64  
e in metallo 20x40 mm  
8 stecche metallo 13 x 22 mm, base a crociera  
Telo in poliestere ECRU 180 gr/m<sup>2</sup>  
con antivento

**ACQUISTABILI SEPARATAMENTE**

OM807241

**TELO DI RICAMBIO OMBRELLONE NEWTON**

m 2x3  
telo in poliestere ECRU 180gr/m<sup>2</sup> con antivento

OM807216

**LED PER OMBRELLONE**

luce a LED con telecomando con altoparlante bluetooth  
per riprodurre musica, con caricatore USB

OM807215

**OMBRELLONE NEWTON NERO P/L 3x3**

NERO, TELO ECRU

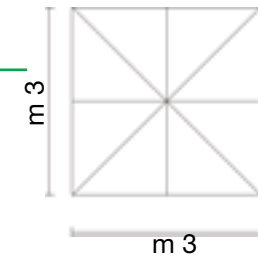
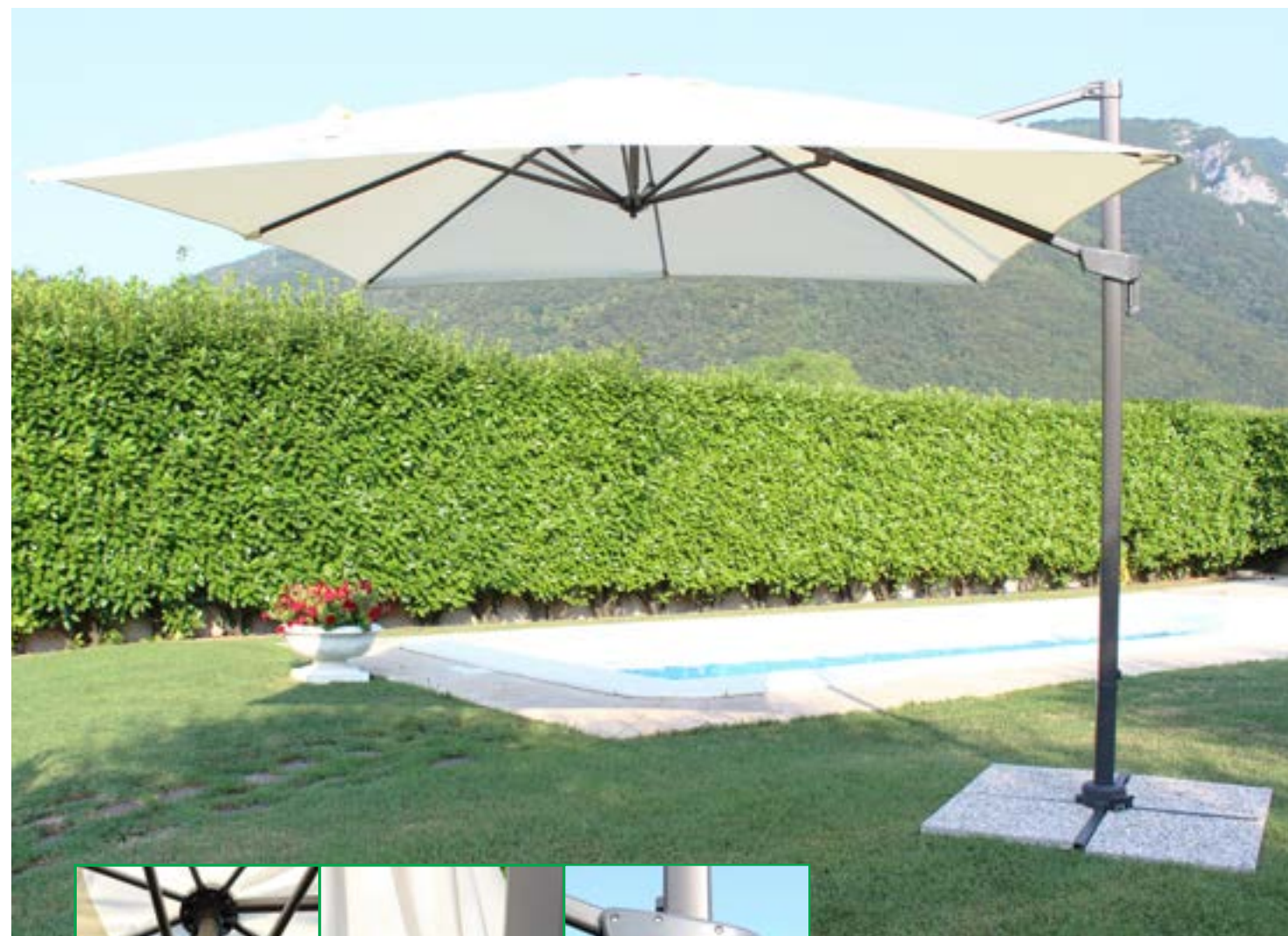

m 3x3

16,7

1



palo girevole in alluminio 45x64  
e in metallo 20x40 mm  
8 stecche metallo 13 x 22 mm, base a crociera  
Telo in poliestere ECRU 180 gr/m<sup>2</sup>  
con antivento

**ACQUISTABILI SEPARATAMENTE**

OM807243

**TELO DI RICAMBIO OMBRELLONE NEWTON**

m 3x3  
telo in poliestere ECRU 180gr/m<sup>2</sup> con antivento

OM807216

**LED PER OMBRELLONE**

luce a LED con telecomando con altoparlante bluetooth  
per riprodurre musica, con caricatore USB

m 3x3

16,7

1





OM807217  
**OMBRELLONE NEWTON NERO P/L 2x3**  
NERO, TELO GRIGIO

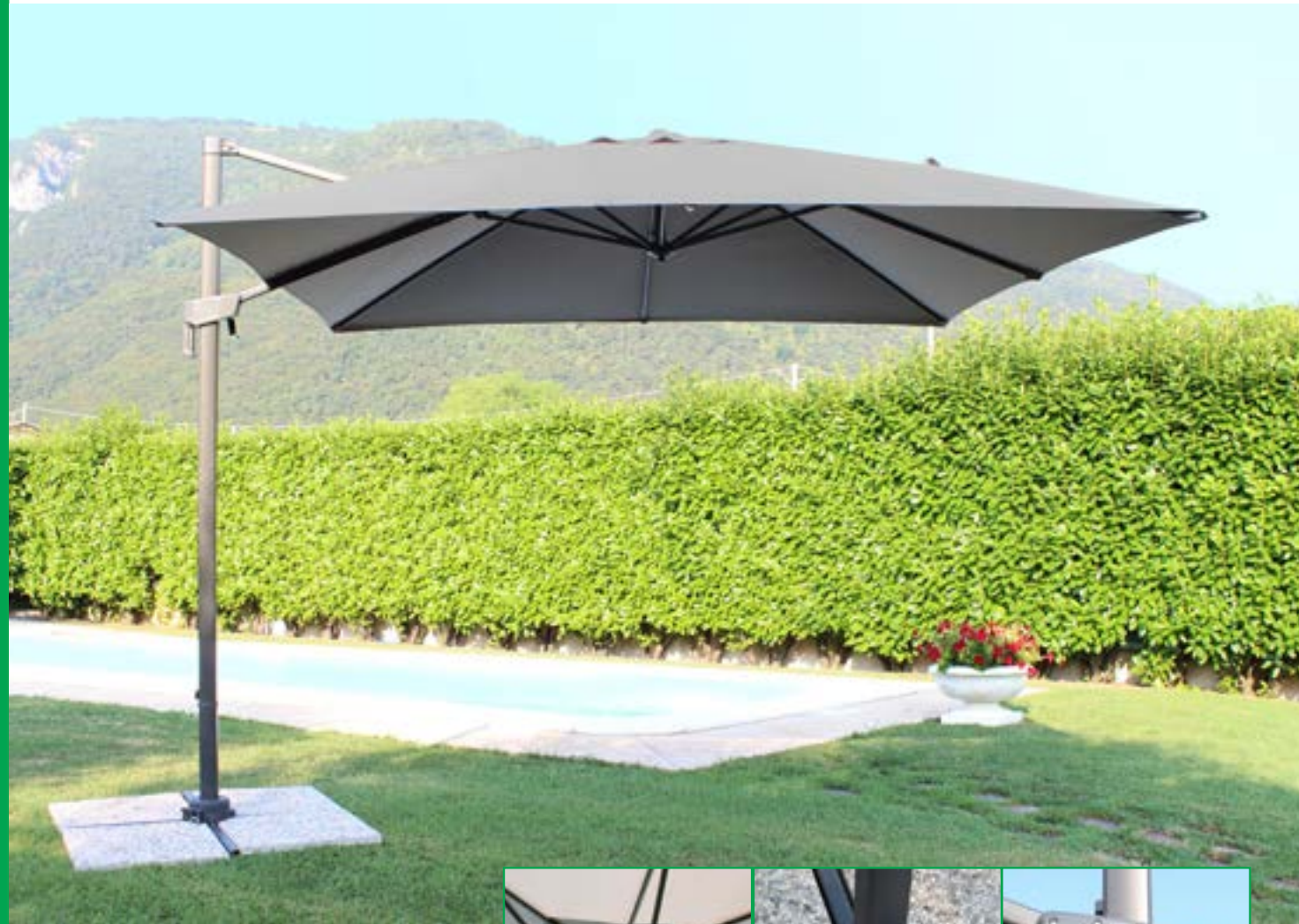
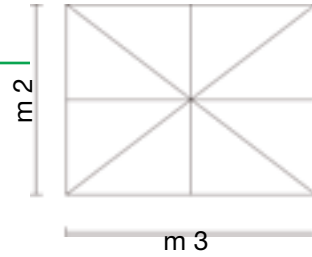

**ACQUISTABILI SEPARATAMENTE**

OM807240  
**TELO DI RICAMBIO OMBRELLONE NEWTON**

m 2x3  
telo in poliestere GRIGIO 180gr/m<sup>2</sup> con antivento

OM807216  
**LED PER OMBRELLONE**

luce a LED con telecomando con altoparlante bluetooth per riprodurre musica, con caricatore USB

m 2x3

17,5

1

palo girevole in alluminio 45x64 e in metallo 20x40 mm  
8 stecche metallo 13 x 22 mm, base a crociera

Telo in poliestere GRIGIO 180 gr/m<sup>2</sup> con antivento

OM807083-TORT  
**OMBRELLONE ZENITH P/L Ø 3**  
TORTORA

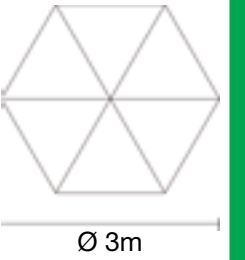

**ACQUISTABILE SEPARATAMENTE**

OM807109  
**TELO DI RICAMBIO OMBRELLONE ZENITH Ø3**

m Ø 3  
Telo in poliestere GRIGIO 180 gr/m<sup>2</sup>

Ø 3m

13

1

Palo in metallo verniciato tortora  
6 stecche in metallo 12x18 mm

Telo in poliestere tortora 180 gr/m<sup>2</sup> con antivento



OM807083-GREY

**OMBRELLONE ZENITH P/L Ø 3**

GRIGIO



Ø 3m

- Ø 3m
- 13
- 1

**ACQUISTABILE SEPARATAMENTE**

OM807109

**TELO DI RICAMBIO OMBRELLONE ZENITH P/L Ø 3**

Ø 3 m  
Telo in poliestere GRIGIO 180 gr/m<sup>2</sup>



Palo in metallo verniciato grigio  
6 stecche in metallo 12x18 mm

Telo in poliestere grigio 180 gr/m<sup>2</sup>  
con antivento

OM807084

**OMBRELLONE ZENITH P/L 2,5x2,5**

GRIGIO



m 2,5

- m 2,5x2,5
- 14
- 1

**ACQUISTABILE SEPARATAMENTE**

OM807110

**TELO DI RICAMBIO OMBRELLONE ZENITH 2,5x2,5**

m 2,5 x 2,5  
Telo in poliestere GRIGIO 180 gr/m<sup>2</sup>



Palo in metallo verniciato grigio  
6 stecche in metallo 12x18 mm

Telo in poliestere grigio 180gr/m<sup>2</sup>  
con mantovana e antivento

OM807085

**OMBRELLONE ZENITH P/L 2x3**

GRIGIO



m 2

m 3

- m 2x3
- 14
- 1

**ACQUISTABILE SEPARATAMENTE**

OM807111

**TELO DI RICAMBIO OMBRELLONE ZENITH 2x3**

m 2x3  
Telo in poliestere GRIGIO 180 gr/m<sup>2</sup>



Palo in metallo verniciato grigio  
6 stecche metallo 12x18 mm

Telo in poliestere grigio 180gr/m<sup>2</sup>  
con antivento



OM806048

**OMBRELLONE ZENITH P/L 2x3**

TORTORA



m 2x3  
14   
1

Palo in metallo verniciato grigio  
6 stecche metallo 12x18 mm

Telo in poliestere 180gr/m<sup>2</sup>, con antivento

**ACQUISTABILE SEPARATAMENTE**

OM807111

**TELO DI RICAMBIO OMBRELLONE ZENITH 2x3**

m 2x3  
Telo in poliestere GRIGIO 180 gr/m<sup>2</sup>



OM806147

**OMBRELLONE ERIS P/L Ø 3**

NERO - TELO BEIGE



Ø 3m   
12   
1

Palo in metallo ø 48/42 mm  
6 stecche metallo 10x18 mm

Telo in poliestere BEIGE 160gr/m<sup>2</sup> con antivento

OM807193

**OMBRELLONE ERIS P/L Ø 3**

BIANCO, TELO BIANCO



Ø 3m   
12   
1

Palo in metallo ø 48/42 mm  
6 stecche metallo 10x18 mm

Telo in poliestere bianco 160gr/m<sup>2</sup> con antivento

OM807190

**OMBRELLONE ERIS P/L Ø 3**

BIANCO, TELO GRIGIO



Ø 3m   
12   
1

Palo in metallo ø 48/42 mm  
6 stecche metallo 10x18 mm

Telo in poliestere grigio 160gr/m<sup>2</sup> con antivento



OM806095

**OMBRELLONE ERIS P/L Ø 3**

NERO, TELO BIANCO



Ø 3m



Ø 3m

12

1

Palo in metallo ø 48/42 mm  
6 stecche metallo 10x18 mm

Telo in poliestere BIANCO 160gr/m<sup>2</sup> con antivento

OM807196

**OMBRELLONE ALMERIA P/L 2,5x2,5**



m 2,5

m 2,5



m 2x3

12,5

1

Palo in metallo verniciato col. antracite  
8 stecche in metallo 10x18 cm

Telo in poliestere bianco 180gr/m<sup>2</sup> con antivento

OM807306

**OMBRELLONE GIOVE P/C 5X5**

ANTRACITE, TELO GRIGIO

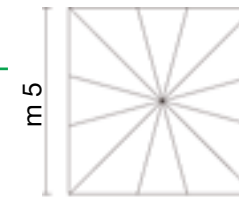

m 5

m 5



m 5x5

74

1

Palo telescopico in alluminio  
verniciato antracite  
12 stecche alluminio 20x40 mm  
palo diam. 10 cm

Telo in poliestere GRIGIO 350gr/m<sup>2</sup>  
con antivento

**ACQUISTABILE SEPARATAMENTE**

OM807307

**TELO DI RICAMBIO OMBRELLONE GIOVE**

m 5x5 / 11 kg / 1pz  
telo GRIGIO ANTRACITE in poliestere 350gr/m<sup>2</sup>

OM807320

**COPERTURA PER OMBRELLONE GIOVE**

copertura GRIGIO ANTRACITE in poliestere 250gr/m<sup>2</sup>  
con cerniera e carrucola, facile da mettere e togliere



OM806058

**OMBRELLONE GIOVE P/C 5X5**

BIANCO - TELO BIANCO



m 5



**ACQUISTABILE SEPARATAMENTE**

OM807124

**TELO DI RICAMBIO OMBRELLONE GIOVE**

m 5x5 / 11 kg / 1pz  
telo BIANCO in poliestere 350gr/m<sup>2</sup>

OM807318

**COPERTURA PER OMBRELLONE GIOVE**

copertura BIANCA in poliestere 250gr/m<sup>2</sup>  
con cerniera e carrucola, facile da mettere e togliere

m 5x5

74

1

Palo telescopico  
in alluminio verniciato bianco  
12 stecche alluminio 20x40 mm,  
palo diam. 10 cm

Telo in poliestere bianco 350gr/m<sup>2</sup>  
con antivento

OM807122

**OMBRELLONE GIOVE P/C 5x5**

TORTORA - TELO TAUPE



m 5



**ACQUISTABILE SEPARATAMENTE**

OM807127

**TELO DI RICAMBIO OMBRELLONE GIOVE**

m 5x5 / 11 kg / 1pz  
telo TAUPE in poliestere 350gr/m<sup>2</sup>

OM807319

**COPERTURA PER OMBRELLONE GIOVE**

copertura TAUPE in poliestere 250gr/m<sup>2</sup>  
con cerniera e carrucola, facile da mettere e togliere

m 5x5

74

1

Palo telescopico  
in alluminio verniciato tortora  
12 stecche alluminio 20x40 mm,  
palo diam. 10 cm

Telo in poliestere TAUPE 350gr/m<sup>2</sup>  
con antivento

OM807001

**OMBRELLONE VENERE DE LUXE P/C Ø 3**

BEIGE



Ø 3m

ø3m

15,5

1

Palo in legno ø 48 mm x240 cm  
8 stecche 20x28 mm intercambiabili  
parti metalliche in acciaio inox

Telo in poliestere beige 270gr/m<sup>2</sup>  
con mantovana e antivento

**ACQUISTABILE SEPARATAMENTE**

OM807077

**TELO DI RICAMBIO VENERE LEGNO Ø3**

m Ø 3  
Telo in poliestere BEIGE 270 gr/m<sup>2</sup>

OM807002

**OMBRELLONE VENERE DE LUXE P/C 2x3**

BEIGE

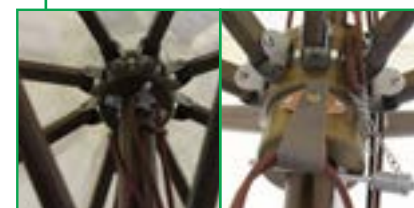

m 3

m 2x3

16

1

palo in legno ø 48 mm x 240 cm  
6stecche 20x28 mm intercambiabili  
parti metalliche in acciaio inox

Telo in poliestere beige 270gr/m<sup>2</sup>  
con mantovana e antivento

**ACQUISTABILE SEPARATAMENTE**

OM807078

**TELO DI RICAMBIO VENERE LEGNO 2x3**

m 2x3  
Telo in poliestere BEIGE 270 gr/m<sup>2</sup>



OM807003

**OMBRELLONE VENERE DELUXE P/C 3x3**

BEIGE

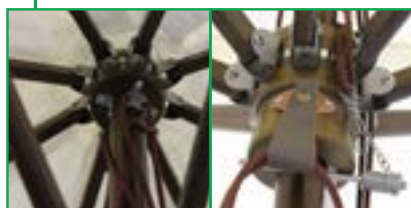
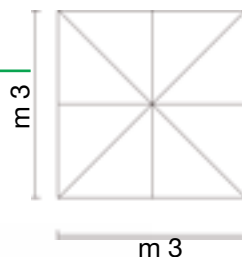

**ACQUISTABILE SEPARATAMENTE**

OM807079

**TELO DI RICAMBIO VENERE LEGNO 3x3**

m 3x3  
Telo in poliestere BEIGE 270 gr/m<sup>2</sup>



m 3x3  
19,8   
1

palo in legno ø 48 x 260 cm  
8 stecche 20 x 35 mm intercambiabili  
parti metalliche in acciaio inox  
Telo in poliestere beige 270gr/m<sup>2</sup>  
con mantovana e antivento

OM807004

**OMBRELLONE VENERE DELUXE P/C 3x4**

BEIGE

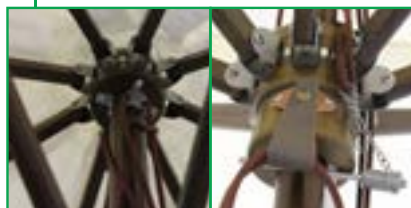
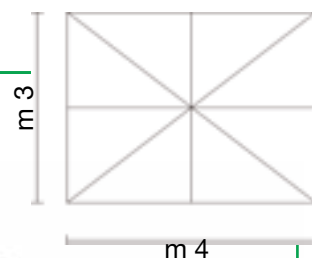

**ACQUISTABILE SEPARATAMENTE**

OM807080

**TELO DI RICAMBIO VENERE LEGNO 3x4**

m 3x4  
Telo in poliestere BEIGE 270 gr/m<sup>2</sup>



m 3x4  
22,5   
1

Palo in legno ø 48 mm x 260 cm  
8 stecche in legno 20x35 mm  
parti metalliche in acciaio inox  
Telo in poliestere beige 270gr/m<sup>2</sup>  
con mantovana e antivento

OM807186-DGRE

**OMBRELLONE CRISTAL P/C 3x3**

GRIGIO SCURO

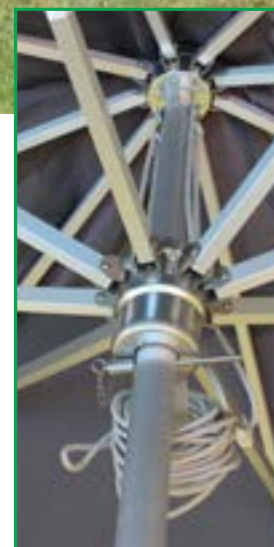
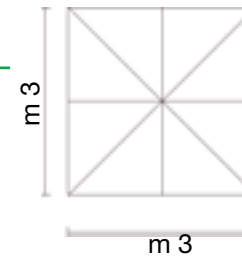

m 3x3  
13   
1

Palo in alluminio ø 48 mm anodizzato, finitura alluminio spazzolato  
noce in alluminio ø 110 mm, 8 stecche alluminio 20x30 mm  
Telo in poliestere grigio scuro 270gr/m<sup>2</sup>  
con antivento



OM807186-LGRE

**OMBRELLONE CRISTAL P/C 3x3**

GRIGIO CHIARO

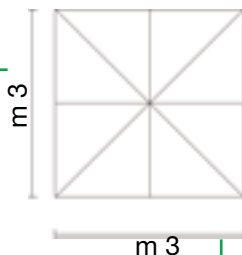

m 3x3  
13 KG  
1 PZ

Palo in alluminio ø 48 mm anodizzato  
finitura alluminio spazzolato  
noce in alluminio ø 110 mm  
8 stecche alluminio 20x30 mm  
Telo in poliestere grigio chiaro 270gr/m<sup>2</sup>  
con antivento

OM807187-LGRE

**OMBRELLONE CRISTAL P/C 3x4**

GRIGIO CHIARO

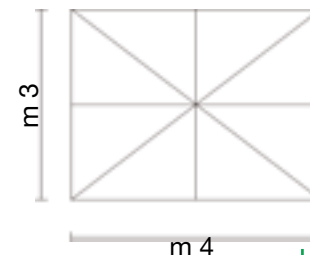

m 3x4  
13 KG  
1 PZ

Palo in alluminio ø 48 mm anodizzato, finitura  
acciaio spazzolato noce in acciaio 110 mm,  
8 stecche alluminio 20x30 mm  
Telo in poliestere grigio chiaro 270gr/m<sup>2</sup>  
con antivento

OM807187-DGRE

**OMBRELLONE CRISTAL P/C 3x4**

GRIGIO SCURO

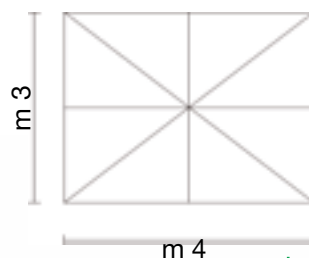

m 3x4  
13 KG  
1 PZ

Palo in alluminio ø 48 mm anodizzato  
finitura alluminio spazzolato  
noce in alluminio ø 110 mm  
8 stecche alluminio 20x30 mm  
Telo in poliestere grigio scuro 270gr/m<sup>2</sup>  
con antivento

OM807188-DGRE

**OMBRELLONE ANDROMEDA P/C ALLUMINIO 3x3**

GRIGIO SCURO

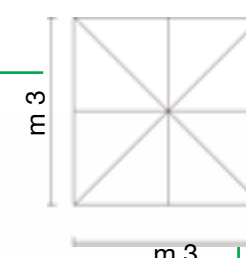

m 3x3  
12 KG  
1 PZ

Palo in alluminio Ø 48 anodizzato, finitura acciaio  
spazzolato, noce in alluminio 115 mm,  
8 stecche alluminio 17x22 mm  
Telo in poliestere grigio scuro 180gr/m<sup>2</sup>  
con antivento



OM807188-LGRE

**OMBRELLONE ANDROMEDA P/C ALLUMINIO 3x3**

GRIGIO CHIARO

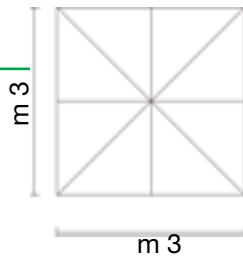

- m 3x3
- 12
- 1

Palo in alluminio Ø 48 anodizzato, finitura alluminio spazzolato, noce in plastica Ø 115 mm, 8 stecche alluminio 17x22 mm

Telo in poliestere grigio chiaro 180gr/m<sup>2</sup> con antivento



OM807189-DGRE

**OMBRELLONE ANDROMEDA P/C ALLUMINIO 3x4**

GRIGIO SCURO

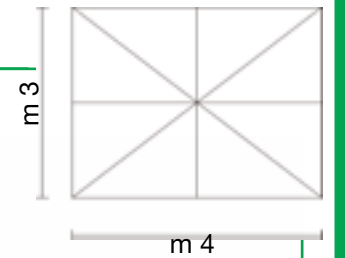

- m 3x3
- 13
- 1

Palo in alluminio Ø 48 anodizzato finitura alluminio spazzolato, noce in plastica Ø 115 mm, 8 stecche alluminio 17x22 mm

Telo in poliestere grigio scuro 180gr/m<sup>2</sup> con antivento

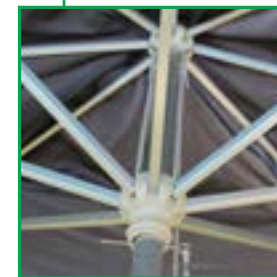

OM807189-LGRE

**OMBRELLONE ANDROMEDA P/C ALLUMINIO 3x4**

GRIGIO CHIARO

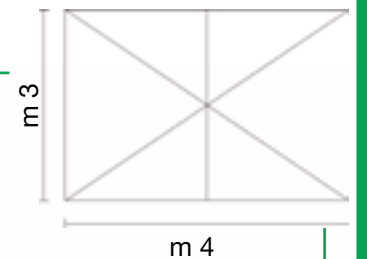

- m 3x4
- 13
- 1

Palo in alluminio Ø 48 anodizzato finitura alluminio spazzolato, noce in plastica Ø 115 mm, 8 stecche alluminio 17x22 mm

Telo in poliestere grigio chiaro 180gr/m<sup>2</sup> con antivento





OM807299

**OMBRELLONE BRIAN P/C 3x3**

NERO - TELO BEIGE



8 057635 313717

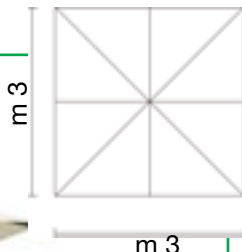

- m 3x3
- 13
- 1

**ACQUISTABILE SEPARATAMENTE**

OM807308

**TELO DI RICAMBIO BRIAN 3x3**

m 3x3  
telo in poliestere BEIGE 235 gr/m<sup>2</sup> con antivento



8 057635 313946

Palo in alluminio ø48 mm con carrucola  
8 stecche alluminio 20x30 mm

Telo in poliestere beige 235 gr/m<sup>2</sup>  
con antivento  
base in cemento acquistabile separatamente



OM807301

**OMBRELLONE BRIAN P/C 3x3**

NERO - TELO GRIGIO



8 057635 313731

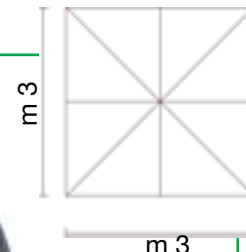

- m 3x3
- 13
- 1

**ACQUISTABILE SEPARATAMENTE**

OM807316

**TELO DI RICAMBIO BRIAN 3x3**

m 3x3  
telo in poliestere GRIGIO 235 gr/m<sup>2</sup> con antivento



8 057635 315360

Palo NERO in alluminio ø48 mm con carrucola  
8 stecche alluminio 20x30 mm

Telo in poliestere grigio 235 gr/m<sup>2</sup>  
con antivento  
base in cemento acquistabile separatamente



OM807300

**OMBRELLONE BRIAN P/C 3x4**

NERO - TELO BEIGE



8 057635 313724

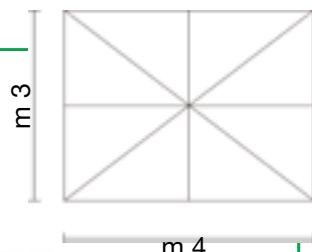

- m 3x4
- 14,4
- 1

**ACQUISTABILE SEPARATAMENTE**

OM807309

**TELO DI RICAMBIO BRIAN 3x4**

m 3x4  
telo in poliestere BEIGE 235 gr/m<sup>2</sup> con antivento



8 057635 313953

Palo in alluminio ø48 mm con carrucola  
8 stecche alluminio 20x30 mm

Telo in poliestere beige 235 gr/m<sup>2</sup>  
con antivento  
base in cemento acquistabile separatamente



OM807302

**OMBRELLONE BRIAN P/C 3x4**

NERO - TELO GRIGIO



8 057635 313748

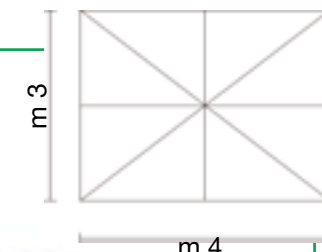

- m 3x4
- 14,4
- 1

**ACQUISTABILE SEPARATAMENTE**

OM807317

**TELO DI RICAMBIO BRIAN 3x4**

m 3x4  
telo in poliestere GRIGIO 235 gr/m<sup>2</sup> con antivento



8 057635 315377

Palo in alluminio ø48 mm con carrucola  
8 stecche alluminio 20x30 mm

Telo in poliestere grigio 235 gr/m<sup>2</sup>  
con antivento  
base in cemento acquistabile separatamente





OM807116  
**OMBRELLONE BRIAN P/C 3x3**

**TORTORA**

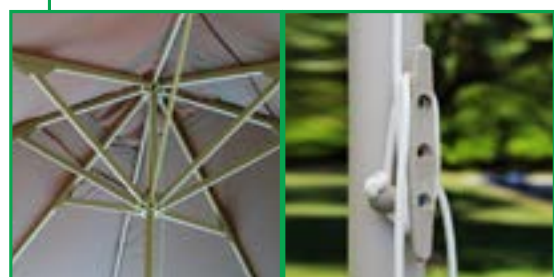
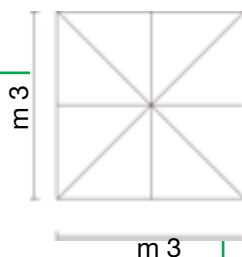

m 3x3  
13   
1

**ACQUISTABILE SEPARATAMENTE**

OM807129

**TELO DI RICAMBIO BRIAN 3x3**

m 3x3 / 3,5 kg / 5pz  
telo in poliestere TORTORA 235gr/m<sup>2</sup> con antivento

Palo in alluminio ø 48 mm con carrucola  
8 stecche alluminio 20x30 mm

Telo in poliestere 235gr/m<sup>2</sup>  
con antivento

OM807119  
**OMBRELLONE BRIAN P/C 3x4**

**TORTORA**

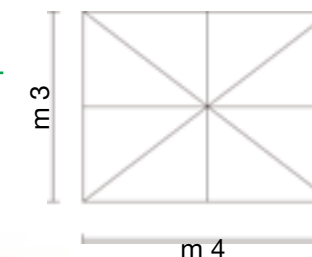

m 3x4  
14,4   
1

**ACQUISTABILE SEPARATAMENTE**

OM807132

**TELO DI RICAMBIO BRIAN 3x4**

m 3x4  
telo in poliestere TORTORA 235 gr/m<sup>2</sup> con antivento

Palo in alluminio ø 48 mm con carrucola  
8 stecche alluminio 20x30 mm

Telo in poliestere 235gr/m<sup>2</sup>  
con antivento

OM807115  
**OMBRELLONE BRIAN P/C 3x3**

**BIANCO**

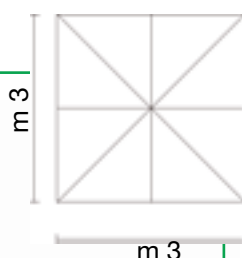

m 3x3  
13   
1

**ACQUISTABILE SEPARATAMENTE**

OM807128

**TELO DI RICAMBIO BRIAN 3x3**

m 3x3 / 3,5 kg / 5pz  
telo in poliestere BIANCO 235 gr/m<sup>2</sup> con antivento

Palo in alluminio ø 48 mm con carrucola  
8 stecche alluminio 20x30 mm

Telo in poliestere 235 gr/m<sup>2</sup>  
con antivento

OM807118  
**OMBRELLONE BRIAN P/C 3x4**

**BIANCO**

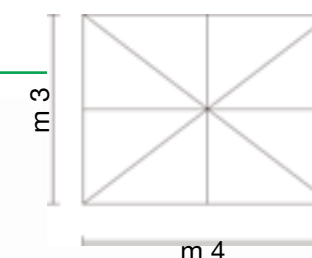

m 3x4  
14,4   
1

**ACQUISTABILE SEPARATAMENTE**

OM807129

**TELO DI RICAMBIO BRIAN 3x4**

m 3x4  
telo in poliestere BIANCO 235gr/m<sup>2</sup> con antivento

Palo in alluminio ø 48 mm con carrucola  
8 stecche alluminio 20x30 mm

Telo in poliestere 235gr/m<sup>2</sup>  
con antivento



OM807181

**OMBRELLONE ORIONE P/C 2x3**

TELO BEIGE

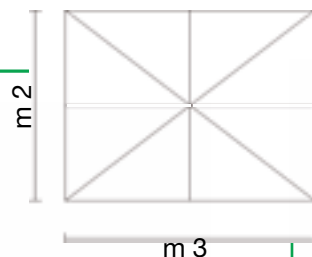

m 2x3

8

1

Palo in legno Ø38mm color teak, noce di abs 115mm doppia carrucola, 6 stecche in legno 17 x 22 mm

Telo in poliestere beige 180gr con antivento



OM807182

**OMBRELLONE ORIONE P/C 3x3**

TELO BEIGE

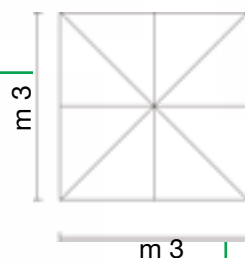

m 3x3

14

1

Palo in legno Ø48mm color teak, noce di abs 115mm doppia carrucola, 8 stecche in legno 17 x 28 mm

Telo in poliestere beige 180gr con antivento



OM807183

**OMBRELLONE ORIONE P/C LEGNO 3x4**

PALO CENTRALE - TELO BEIGE

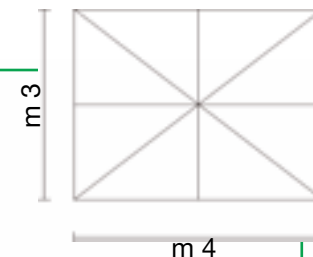

m 3x4

15

1

Palo in legno Ø48mm color teak noce di abs 115mm doppia carrucola, 8 stecche in legno 17x28 mm Telo in poliestere 180gr con antivento

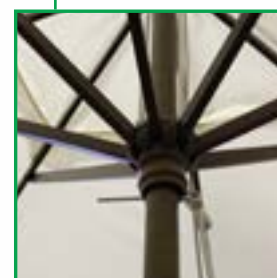

OM807013

**OMBRELLONE FANTASY Ø 3**

PALO CENTRALE



Ø3m

11

1

palo in legno Ø48 mm 8 stecche Telo in poliestere 180gr/m<sup>2</sup> con antivento e mantovana

TELO DISPONIBILE

Avorio

Verde scuro



OM807014

**OMBRELLONE FANTASY Ø 2,5**

PALO CENTRALE



8 033695 767219



Ø 2,5 m

Ø 2,5m

6 KG

1 PZ

palo in legno Ø38 mm  
6 stecche  
Telo in poliestere 180gr/m<sup>2</sup>  
con antivento e mantovana

TELO DISPONIBILE

Avorio

Verde scuro

OM807016

**OMBRELLONE FANTASY 3x3**

PALO CENTRALE



8 033695 767400



m 3

m 3

m 3x3

14 KG

1 PZ

palo in legno Ø48 mm  
8 stecche  
Telo in poliestere 180gr/m<sup>2</sup>  
con antivento e mantovana

TELO DISPONIBILE

Avorio

Verde scuro

OM807015

**OMBRELLONE FANTASY 2x3**

PALO CENTRALE



8 033695 767325



m 2

m 3

m 2x3

8 KG

1 PZ

palo in legno Ø38 mm  
6 stecche  
Telo in poliestere 180gr/m<sup>2</sup>  
con antivento e mantovana

TELO DISPONIBILE

Avorio

Verde scuro

OM807017

**OMBRELLONE FANTASY 3x4**

PALO CENTRALE



8 056772 885927



m 3

m 4

m 3x4

16 KG

1 PZ

palo in legno Ø48 mm  
8 stecche  
Telo in poliestere 180gr/m<sup>2</sup>  
con antivento e mantovana

TELO DISPONIBILE

Avorio

Verde scuro



OM807135

**OMBRELLONE MERCURIO P/C 3x3**

TORTORA - TELO ECRU

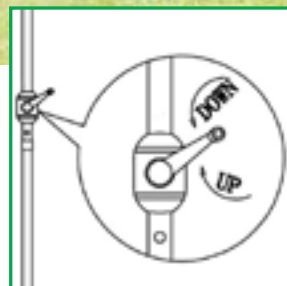
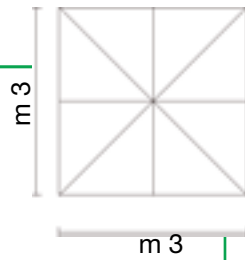

- m 3x3
- 13
- 1

**ACQUISTABILE SEPARATAMENTE**

OM806145-BEIG

**TELO DI RICAMBIO MERCURIO 3x3**

m 3x3  
telo in poliestere ECRU 200gr/m<sup>2</sup>

Palo in metallo ø 48 mm con manovella  
8 stecche in metallo 12x23 mm

Telo in poliestere ecrù 180gr/m<sup>2</sup> con antivento

OM807138

**OMBRELLONE MERCURIO P/C 3x4**

TORTORA, TELO ECRU

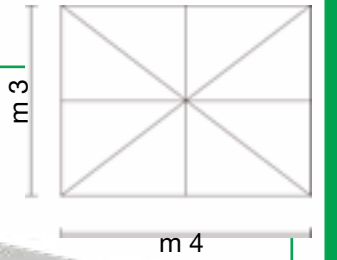

- m 3x4
- 14
- 1

**ACQUISTABILE SEPARATAMENTE**

OM806146-BEIG

**TELO DI RICAMBIO MERCURIO 3x4**

m 3x4  
telo in poliestere ECRU 200gr/m<sup>2</sup>

Palo in metallo ø 48 mm con carrucola  
8 stecche in metallo 12x23 mm

Telo in poliestere ecrù 180gr/m<sup>2</sup>  
con antivento

OM807136

**OMBRELLONE MERCURIO P/C 3x3**

TORTORA - TELO GRIGIO

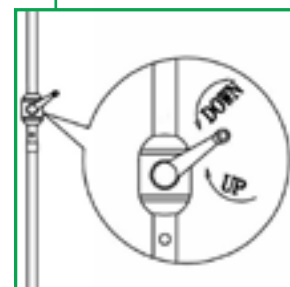
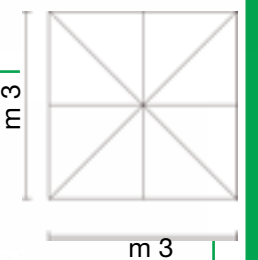

- m 3x3
- 13
- 1

**ACQUISTABILE SEPARATAMENTE**

OM806145-GREY

**TELO DI RICAMBIO MERCURIO 3x3**

m 3x3  
telo in poliestere GRIGIO 200gr/m<sup>2</sup>

Palo in metallo ø 48 mm con manovella  
8 stecche in metallo 12x23 mm

Telo in poliestere grigio 180gr/m<sup>2</sup>  
con antivento



OM807139

**OMBRELLONE MERCURIO P/C 3x4**

TORTORA - TELO GRIGIO

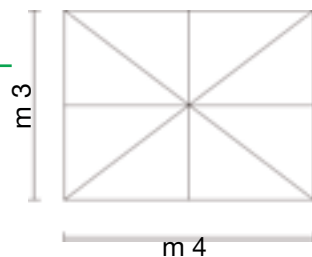

m 3x4

14

1

**ACQUISTABILE SEPARATAMENTE**

OM806146-GREY

**TELO DI RICAMBIO MERCURIO 3x4**

m 3x4  
telo in poliestere GRIGIO 200gr/m<sup>2</sup>

Palo in metallo ø 48 mm con carrucola  
8 stecche in metallo 12x23 mm

Telo in poliestere ecrù 180gr/m<sup>2</sup>  
con antivento

OM807270

**OMBRELLONE MERCURIO P/C 3x3**

NERO - TELO GRIGIO

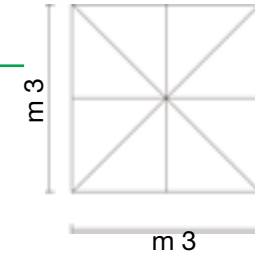

m 3x3

13

1

**ACQUISTABILE SEPARATAMENTE**

OM806145-GREY

**TELO DI RICAMBIO MERCURIO 3x3**

m 3x3  
telo in poliestere GRIGIO 200gr/m<sup>2</sup>

Palo in metallo ø 48 mm con manovella  
8 stecche in metallo 12x23 mm

Telo in poliestere grigio 180gr/m<sup>2</sup>  
con antivento

OM807271

**OMBRELLONE MERCURIO P/C 3x4**

NERO - TELO GRIGIO

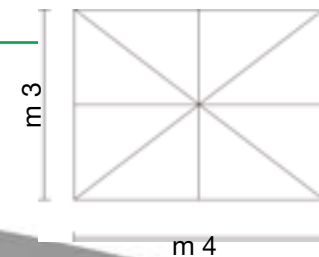

m 3x4

14

1

**ACQUISTABILE SEPARATAMENTE**

OM806146-GREY

**TELO DI RICAMBIO MERCURIO 3x4**

m 3x4  
telo in poliestere GRIGIO 200gr/m<sup>2</sup>

Palo in metallo ø 48 mm con carrucola  
8 stecche in metallo 12x23 mm

Telo in poliestere grigio 180gr/m<sup>2</sup>  
con antivento



OM807288

**OMBRELLONE MERCURIO P/C 3x3**

NERO - TELO ECRU



m 3

m 3x3

13

1

**ACQUISTABILE SEPARATAMENTE**

OM806145-BEIG

**TELO DI RICAMBIO MERCURIO 3x3**

m 3x3  
telo in poliestere ECRU 200gr/m<sup>2</sup>

Palo in metallo ø 48 mm con manovella  
8 stecche in metallo 12x23 mm

Telo in poliestere grigio 180gr/m<sup>2</sup>  
con antivento

Base in cemento acquistabile separatamente

OM807289

**OMBRELLONE MERCURIO P/C 3x3**

NERO - TELO VERDE

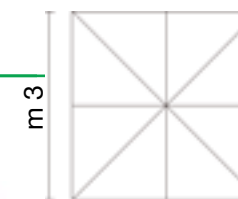
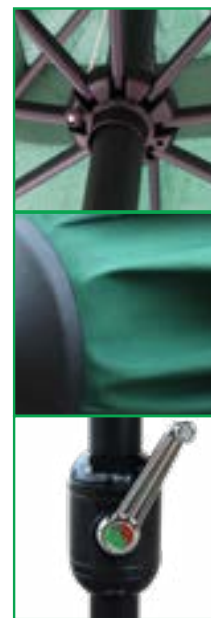

m 3

m 3x3

13

1

**ACQUISTABILE SEPARATAMENTE**

OM806145-VRD

**TELO DI RICAMBIO MERCURIO 3x3**

m 3x3  
telo in poliestere VERDE 200gr/m<sup>2</sup>

Palo in metallo ø 48 mm con manovella  
8 stecche in metallo 12x23 mm

Telo in poliestere verde 180gr/m<sup>2</sup>  
con antivento

Base in cemento acquistabile separatamente

OM807290

**OMBRELLONE MERCURIO P/C 3x4**

NERO - TELO ECRU



m 3

m 4

m 3x4

14

1

**ACQUISTABILE SEPARATAMENTE**

OM806146-BEIG

**TELO DI RICAMBIO MERCURIO 3x4**

m 3x4  
telo in poliestere ECRU 200gr/m<sup>2</sup>

Palo in metallo ø48mm con carrucola  
8 stecche in metallo 12x23 mm

Telo in poliestere grigio 180gr/m<sup>2</sup>  
con antivento

Base in cemento acquistabile separatamente

OM807291

**OMBRELLONE MERCURIO P/C 3x4**

NERO - TELO VERDE

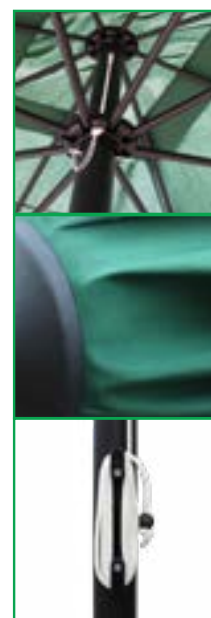

m 3

m 4

m 3x4

14

1

**ACQUISTABILE SEPARATAMENTE**

OM806146-VRD

**TELO DI RICAMBIO MERCURIO 3x4**

m 3x4  
telo in poliestere VERDE 200gr/m<sup>2</sup>

Palo in metallo ø 48 mm con carrucola  
8 stecche in metallo 12x23 mm

Telo in poliestere verde 180gr/m<sup>2</sup>  
con antivento

Base in cemento acquistabile separatamente



OM807303

**OMBRELLONE NICE P/C 2x2**

NERO - TELO GRIGIO

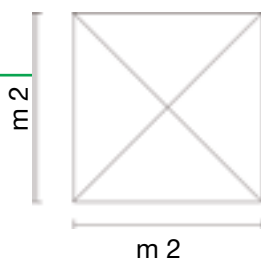

m 2x2  
3,8 KG  
1 PZ

palo reclinabile in alluminio ø38mm  
verniciato nero  
4 stecche in alluminio 12 x 18 mm  
apertura/chiusura tramite manovella

Telo in poliestere 180 gr/m<sup>2</sup> con antivento  
base in cemento acquistabile separatamente



OM807304

**OMBRELLONE NICE P/C 2x3**

NERO - TELO GRIGIO

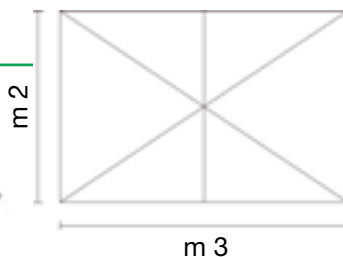

m 2x3  
3,8 KG  
1 PZ

palo reclinabile in alluminio ø38mm  
verniciato nero  
4 stecche in alluminio 12 x 18 mm  
apertura/chiusura tramite manovella

Telo in poliestere 180 gr/m<sup>2</sup> con antivento  
base in cemento acquistabile separatamente



OM806080

**OMBRELLONE NICE P/C Ø 3**

BIANCO

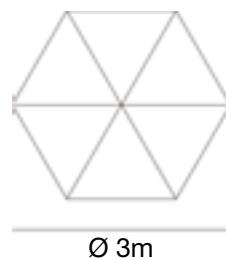

Ø m3  
3,8 KG  
1 PZ

palo reclinabile in alluminio ø38mm  
verniciato nero  
4 stecche in alluminio 12 x 18 mm  
apertura/chiusura tramite manovella

Telo in poliestere 180 gr/m<sup>2</sup> con antivento  
base in cemento acquistabile separatamente



OM806101

**OMBRELLONE NICE P/C 2x2**

TAUPE

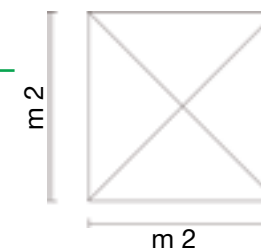

m 2x2  
3,8 KG  
1 PZ

palo in alluminio ø 38 mm taupe  
4 stecche in alluminio 12 x 18 mm  
apertura/chiusura tramite manovella

Telo in poliestere 180 gr/m<sup>2</sup> con antivento  
base in cemento acquistabile separatamente



OM806046

**OMBRELLONE NICE P/C 2x2**

TORTORA

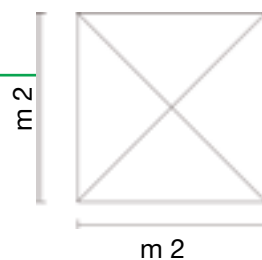

- m 2x2
- 3,8
- 1

palo in alluminio ø 38 mm taupe  
4 stecche in alluminio 12 x 18 mm  
apertura/chiusura tramite manovella  
Telo in poliestere 180 gr/m<sup>2</sup> con antivento  
base in cemento acquistabile separatamente



OM806083-IVRY

**OMBRELLONE NICE P/C 2x2**

NERO

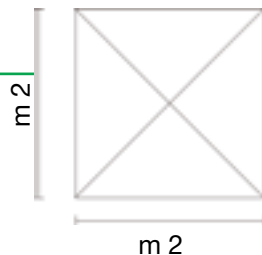

- m 2x2
- 3,8
- 1

palo in alluminio ø 38 mm taupe  
4 stecche in alluminio 12 x 18 mm  
apertura/chiusura tramite manovella  
Telo in poliestere 180 gr/m<sup>2</sup> con antivento  
base in cemento acquistabile separatamente



OM806080

**OMBRELLONE NICE P/C 2x2**

BIANCO

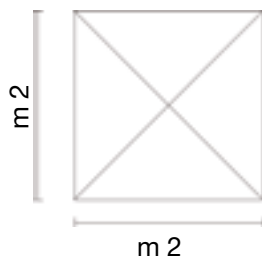

- m 2x2
- 3,8
- 1

palo in alluminio ø 38 mm taupe  
4 stecche in alluminio 12 x 18 mm  
apertura/chiusura tramite manovella  
Telo in poliestere 180 gr/m<sup>2</sup> con antivento  
base in cemento acquistabile separatamente

OM806084-IVRY

**OMBRELLONE NICE P/C 2x3**

NERO

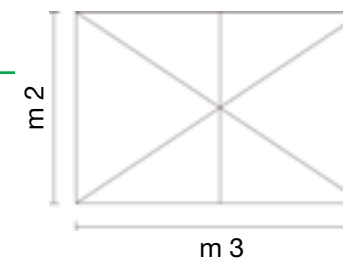

- m 2x3
- 4,9
- 1

palo in alluminio ø 38 mm nero  
6 stecche in alluminio 12x18 mm  
apertura/chiusura tramite manovella  
Telo in poliestere 180 gr/m<sup>2</sup> con antivento  
base in cemento acquistabile separatamente



- m 2x3
- 4,9
- 1



OM806047

**OMBRELLONE NICE P/C 2x3**

**TORTORA**

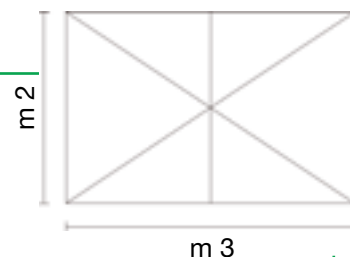

m 3

m 2x3

4,9

1

palo in alluminio ø 38mm  
6 stecche in alluminio 12x18 mm  
apertura/chiusura tramite manovella

Telo in poliestere 180 gr/m<sup>2</sup> con antivento  
base in cemento acquistabile separatamente



OM806081

**OMBRELLONE NICE P/C 2x3**

**BIANCO**

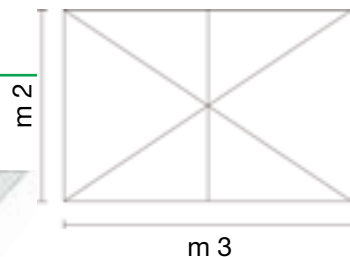

m 3

m 2x3

4,9

1

palo in alluminio ø 38mm  
6 stecche in alluminio 12x18 mm  
apertura/chiusura tramite manovella

Telo in poliestere 180 gr/m<sup>2</sup> con antivento  
base in cemento acquistabile separatamente

OM806102

**OMBRELLONE NICE P/C 2x3**

**TAUPE**

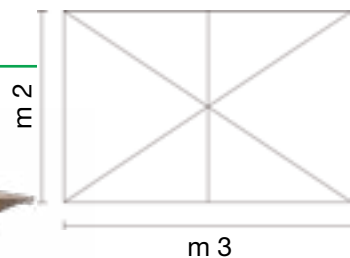

m 3

m 2x3

4,9

1

palo in alluminio taupe ø 38mm  
6 stecche in alluminio 12x18 mm  
apertura/chiusura tramite manovella

Telo in poliestere 180 gr/m<sup>2</sup> con antivento  
base in cemento acquistabile separatamente

OM806079

**OMBRELLONE NICE P/C Ø 3**

**BIANCO**

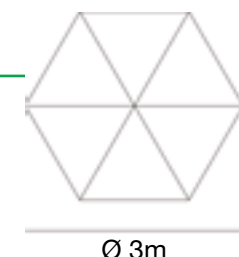

Ø 3m



Ø m3

3,8

1

Palo in alluminio ø 38 mm  
6 stecche alluminio 12x18 mm  
apertura/chiusura tramite manovella

Telo in poliestere 180 gr/m<sup>2</sup> con antivento  
base in cemento acquistabile separatamente



OM806045

**OMBRELLONE NICE P/C Ø 3**

TORTORA



Ø 3m

Ø m3  
3,8   
1

Palo in alluminio Ø 38 mm  
6 stecche alluminio 12x18 mm  
apertura/chiusura tramite manovella  
Telo in poliestere 180 gr/m<sup>2</sup> con antivento  
base in cemento acquistabile separatamente

OM806103

**OMBRELLONE NICE P/C Ø 3**

TAUPE



Ø 3m

Ø m3  
3,8   
1

Palo in alluminio Ø 38 mm  
6 stecche alluminio 12x18 mm  
apertura/chiusura tramite manovella  
Telo in poliestere 180 gr/m<sup>2</sup> con antivento  
base in cemento acquistabile separatamente

OM806082-IVRY

**OMBRELLONE NICE P/C Ø 3**

NERO

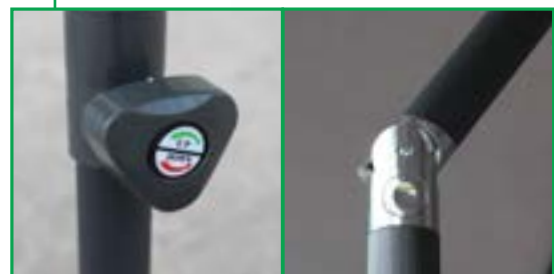

Ø 3m

Ø m3  
3,8   
1

Palo in alluminio Ø 38 mm  
6 stecche alluminio 12x18 mm  
apertura/chiusura tramite manovella  
Telo in poliestere 180 gr/m<sup>2</sup> con antivento  
base in cemento acquistabile separatamente

OM806096

**OMBRELLONE POLY ECO P/C 2x3**

PALO NERO, TELO BIANCO



m 2

m 3



m 2x3  
6   
1

palo in metallo nero Ø 38 mm con manovella  
6 stecche in metallo 12 x 18 mm  
apertura/chiusura tramite manovella  
Telo in poliestere bianco 160gr/m<sup>2</sup> con antivento  
base in cemento acquistabile separatamente



OM807195

**OMBRELLONE POLY ECO P/C 2x3**

PALO BIANCO, TELO BIANCO

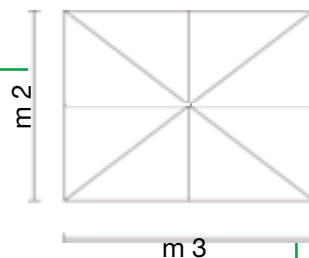

m 2x3

6

1

palo in metallo nero Ø 38 mm con manovella  
6 stecche in metallo 12 x 18 mm  
apertura/chiusura tramite manovella

Telo in poliestere bianco 160gr/m<sup>2</sup> con antivento  
base in cemento acquistabile separatamente

OM807192

**OMBRELLONE POLY ECO P/C 2x3**

PALO BIANCO, TELO GRIGIO

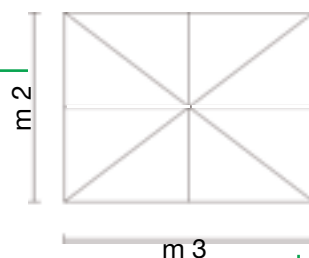

m 2x3

6

1

palo in metallo nero Ø 38 mm con manovella  
6 stecche in metallo 12 x 18 mm  
apertura/chiusura tramite manovella

Telo in poliestere bianco 160gr/m<sup>2</sup> con antivento  
base in cemento acquistabile separatamente

OM806097

**OMBRELLONE POLY ECO P/C Ø 3**

PALO NERO, TELO BIANCO

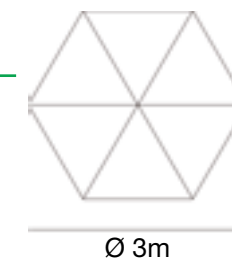

Ø 3m

Ø m3

4

1

Palo in metallo nero ø 38mm con manovella  
6 stecche in metallo 12x18 mm  
apertura/chiusura tramite manovella

Telo in poliestere bianco 160gr/m<sup>2</sup> con antivento  
base in cemento acquistabile separatamente





OM807194

**OMBRELLONE POLY ECO P/C Ø 3**

PALO BIANCO, TELO BIANCO



Ø 3m

Ø m3

4 KG

1 PZ

Palo in metallo nero ø 38mm con manovella  
6 stecche in metallo 12x18 mm  
apertura/chiusura tramite manovella

Telo in poliestere bianco 160gr/m<sup>2</sup> con antivento  
base in cemento acquistabile separatamente

OM807191

**OMBRELLONE POLY ECO P/C Ø 3**

PALO BIANCO, TELO GRIGIO



Ø 3m

Ø m3

4 KG

1 PZ

Palo in metallo nero ø 38mm con manovella  
6 stecche in metallo 12x18 mm  
apertura/chiusura tramite manovella

Telo in poliestere bianco 160gr/m<sup>2</sup> con antivento  
base in cemento acquistabile separatamente

OM806031

**BASE MINI DA KG 15 CON TUBO Ø38**



Base ombrellone in ghiaio lavato completa di tubo in metallo zincato  
Ø interno 35 mm

Ø42 cm

15 KG

1 PZ

OM806032

**BASE PICCOLA DA KG 25 CON TUBO Ø45 DG**



Base ombrellone in ghiaio lavato, completa di tubo in metallo zincato  
con doppio galletto Ø interno 42 mm

Ø44cm

25 KG

1 PZ

OM806033

**BASE MEDIA DA KG 35 CON TUBO Ø55 DG**



Base ombrellone in ghiaio lavato, completa di tubo in metallo zincato  
con doppio galletto Ø interno 52 mm

Ø54 cm

35 KG

1 PZ

OM806034

**BASE GRANDE DA KG 55 CON TUBO Ø60 DG**



Base ombrellone in ghiaio lavato, completa di tubo in metallo zincato  
con doppio galletto Ø interno 52 mm

Ø59 cm

55 KG

1 PZ

OM806035

**BASE QUADRA 50x50**



Base ombrellone in ghiaio lavato

cm 50x50

21 KG

1 PZ

OM806036

**BASE QUADRA 40x40**



Base ombrellone in ghiaio lavato

cm 40x40

17 KG

1 PZ





PN802222

## PENSILINA SUN OPACA 90 X 140

cm 90 x 140 / P.90 x 140



1



8 051811 466396

Pensilina con braccetti in ALLUMINIO GRIGIO  
Policarbonato 2 mm



PN802223

## PENSILINA SUN OPACA 90 X 160

cm 90 x 160 / P.90 x 160



1



8 051811 466396

Pensilina con braccetti in ALLUMINIO GRIGIO  
Policarbonato 2 mm



PN802224

## PENSILINA SUN OPACA 120 X 140

cm 90 x 160 / P.90 x 160



1



8 051811 466402

Pensilina con braccetti in ALLUMINIO GRIGIO  
Policarbonato 2 mm



PN802225

## PENSILINA SUN OPACA 120 X 160

cm 120 x 160 / P.120 x 160



1



8 051811 466419

Pensilina con braccetti in ALLUMINIO GRIGIO  
Policarbonato 2 mm



# Pensiline





PN802201 **PENSILINA CON LED RAINBOW TRASPARENTE 100 X 120** cm 100 x 120 / P.95 x 115  
 1 pz  
 Pencilina con LED, SENSORE, PANNELLO SOLARE e braccetti in ABS Policarbonato 2,7 mm, si ricarica da solo non ha bisogno di manutenzione

PN802202 **PENSILINA CON LED RAINBOW TRASPARENTE 100 X 150** cm 100 x 150 / P.95 x 145  
 1 pz  
 Pencilina con LED, SENSORE, PANNELLO SOLARE e braccetti in ABS Policarbonato 2,7 mm, si ricarica da solo non ha bisogno di manutenzione

PN802203 **PENSILINA CON LED RAINBOW OPACA 100 X 120** cm 100 x 120 / P.95 x 115  
 1 pz  
 Pencilina con LED, SENSORE, PANNELLO SOLARE e braccetti in ABS Policarbonato 2,7 mm, si ricarica da solo non ha bisogno di manutenzione

PN802204 **PENSILINA CON LED RAINBOW OPACA 100 X 150** cm 100 x 150 / P.95 x 145  
 1 pz  
 Pencilina con LED, PANNELLO SOLARE e braccetti in ABS Policarbonato 2,7 mm, si ricarica da solo non ha bisogno di manutenzione

PN802205 **PENSILINA CON LED RAINBOW ALVEOLARE OPACO 100 X 120** cm 100 x 120 / P.95 x 115  
 1 pz  
 Pencilina con LED, PANNELLO SOLARE e braccetti in ABS Policarbonato 5,2 mm, si ricarica da solo non ha bisogno di manutenzione

PN802206 **PENSILINA CON LED RAINBOW ALVEOLARE OPACO 100 X 150** cm 100 x 150 / P.95 x 145  
 1 pz  
 Pencilina con LED, PANNELLO SOLARE e braccetti in ABS Policarbonato 5,2 mm, si ricarica da solo non ha bisogno di manutenzione



PN802207 **PENSILINA RAIN ALVEOLARE OPACO 60 X 100** cm 60 x 100 / P.61 x 95  
 1 pz  
 Pencilina con braccetti in ABS Policarbonato 3,2 mm

PN802208 **PENSILINA RAIN TRASPARENTE 80 X 100** cm 80 x 100 / P.75 x 95  
 1 pz  
 Pencilina con braccetti in ABS Policarbonato 2,7 mm

PN802209 **PENSILINA RAIN TRASPARENTE 80 X 120** cm 80 x 120 / P.75 x 115  
 1 pz  
 Pencilina con braccetti in ABS Policarbonato 2,7 mm



PN802210

**PENSILINA RAIN OPACA**  
**80 X 100**



cm 80 x 100 / P.75 x 95 ↙ ↘

1

Pensilina con braccetti in ABS  
Policarbonato 2,7 mm

PN802211

**PENSILINA RAIN OPACA**  
**80 X 120**



cm 80 x 120 / P.75 x 115 ↙ ↘

1

Pensilina con braccetti in ABS  
Policarbonato 2,7 mm

PN802212

**PENSILINA RAIN ALVEOLARE OPACO**  
**80 X 100**



cm 80 x 100 / P.75 x 95 ↙ ↘

1

Pensilina con braccetti in ABS  
Policarbonato 5,2 mm

PN802213

**PENSILINA RAIN ALVEOLARE OPACO**  
**80 X 120**



cm 80 x 120 / P.75 x 115 ↙ ↘

1

Pensilina con braccetti in ABS  
Policarbonato 5,2 mm

PN802214

**PENSILINA RAIN TRASPARENTE**  
**100 X 120**



cm 100 x 120 / P.98 x 115 ↙ ↘

1

Pensilina con braccetti in ABS  
Policarbonato 2,7 mm

PN802215

**PENSILINA RAIN TRASPARENTE**  
**100 X 150**



cm 100 x 150 / P.98 x 145 ↙ ↘

1

Pensilina con braccetti in ABS  
Policarbonato 2,7 mm

PN802216

**PENSILINA RAIN OPACA**  
**100 X 120**



cm 100 x 120 / P.98 x 115 ↙ ↘

1

Pensilina con braccetti in ABS  
Policarbonato 2,7 mm

PN802217

**PENSILINA RAIN OPACA**  
**100 X 150**



cm 100 x 150 / P.98 x 145 ↙ ↘

1

Pensilina con braccetti in ABS  
Policarbonato 2,7 mm

PN802218

**PENSILINA RAIN ALVEOLARE OPACO**  
**100 X 120**



cm 100 x 120 / P.98 x 115 ↙ ↘

1

Pensilina con braccetti in ABS  
Policarbonato 5,2 mm

PN802219

**PENSILINA RAIN ALVEOLARE OPACO**  
**100 X 150**



cm 100 x 150 / P.98 x 145 ↙ ↘

1

Pensilina con braccetti in ABS  
Policarbonato 5,2 mm

PN802220

**PENSILINA RAIN ALVEOLARE OPACO**  
**120 X 120**



cm 120 x 120 / P.120 x 120 ↙ ↘

1

Pensilina con braccetti in ABS  
Policarbonato 5,2 mm

PN802221

**PENSILINA RAIN ALVEOLARE OPACO**  
**120 X 150**



cm 120 x 150 / P.120 x 150 ↙ ↘

1

Pensilina con braccetti in ABS  
Policarbonato 5,2 mm







MF802642

## SET DI 2 SCAFFALI DORIANE

BIANCO ANTICO



G.27x27x162/P.22x22x125 ↗

1

Set di 2 scaffali in metallo  
verniciato a polvere  
BIANCO  
trattamento elettroforesi

MF802636

## SCAFFALE EMMA 4 PIANI

BIANCO ANTICO



cm 60 x 32 x 160 h ↗

1

Scaffale in metallo 4 piani  
verniciato a polvere  
BIANCO  
trattamento elettroforesi

MF802637

## SCAFFALE ISABELLE 3 PIANI

BIANCO ANTICO



cm 60 x 32 x 121 h ↗

1

Scaffale in metallo 3 piani  
verniciato a polvere  
BIANCO  
trattamento elettroforesi

# Complementi in metallo



MF802639

**SCAFFALE ELEONORA 5 PIANI**

BIANCO ANTICO



8 056772 884968



cm 32 x 22 x 165 h



Scaffale in metallo 5 piani  
verniciato a polvere  
BIANCO  
trattamento elettroforesi

MF802623

**ÉTAGÈRE DOMINIQUE**

BIANCO ANTICO



8 053251 684002



cm 46 x 32 x 5,70 h



Étagère in metallo 3 piani verniciato  
a polvere BIANCO  
trattamento elettroforesi

MF802640

**SCAFFALE ARIANNE 5 PIANI**

AD ANGOLO - BIANCO ANTICO



8 056772 884975



cm 50 x 35 x 175 h



Scaffale in metallo 5 piani  
verniciato a polvere  
BIANCO  
trattamento elettroforesi

MF802615

**ÉTAGÈRE NOELLE 4 PIANI**

BIANCO ANTICO



8 053251 683920



cm 61 x 32 x 156 h



Étagère in metallo 4 piani  
verniciato a polvere  
BIANCO  
trattamento elettroforesi

MF802659

**ÉTAGÈRE KIMBERLY**

BIANCO ANTICO



8 056772 885064



cm 37,5 x 51 x 81 h



Étagère in metallo per fiori  
verniciato a polvere  
BIANCO  
trattamento elettroforesi

MF802616

**ÉTAGÈRE CHARLOTTE 4 PIANI**

BIANCO ANTICO



8 053251 683937



cm 49 x 35 x 154 h



Étagère in metallo 4 piani  
verniciato a polvere  
BIANCO  
trattamento elettroforesi



MF802618

**ÉTAGÈRE CLAUDE 3 PIANI**

BIANCO ANTICO



8 053251 683951



cm 61 x 32 x 117 h



1

Étagère in metallo 3 piani  
verniciato a polvere  
BIANCO  
trattamento elettroforesi

MF802611

**ÉTAGÈRE FLORIANCE 4 PIANI**

BIANCO ANTICO



8 053251 683883



cm 60 x 31 x 60 x 158 h



1

Étagère in metallo 4 piani  
verniciato a polvere  
BIANCO  
trattamento elettroforesi

MF802619

**ÉTAGÈRE ROSALIE 3 PIANI**

BIANCO ANTICO



8 053251 683968



cm 49 x 35 x 115 h



2

Étagère in metallo 3 piani  
verniciato a polvere  
BIANCO  
trattamento elettroforesi

MF802621

**SET DI 3 FIORIERE VALERIE**



8 053251 683982



G.Ø32x72/M.Ø27x62P.Ø22x52



1

Set di 3 stand in metallo  
verniciati a polvere  
BIANCO  
trattamento elettroforesi

MF802620

**ÉTAGÈRE SELENE**

BIANCO ANTICO



8 053251 683975



cm 60 x 32 x 128 h



2

Étagère in metallo  
verniciato a polvere  
BIANCO  
trattamento elettroforesi

MF802622

**SET DI 3 FIORIERE VINCENT**

BIANCO ANTICO



8 053251 683999



G.30x72/M.25x62/P.20x52



32

Set di 3 stand in metallo  
verniciati a polvere  
BIANCO  
trattamento elettroforesi



MF802656

**PANCA DOLLIE**

BIANCO ANTICO



8 056772 885033



cm 103 x 54 x 95 h



1



Panca in metallo  
verniciato a polvere  
BIANCO  
trattamento elettroforesi



MF802644

**ARCO ANDERSON**

BIANCO ANTICO



8 056772 885132

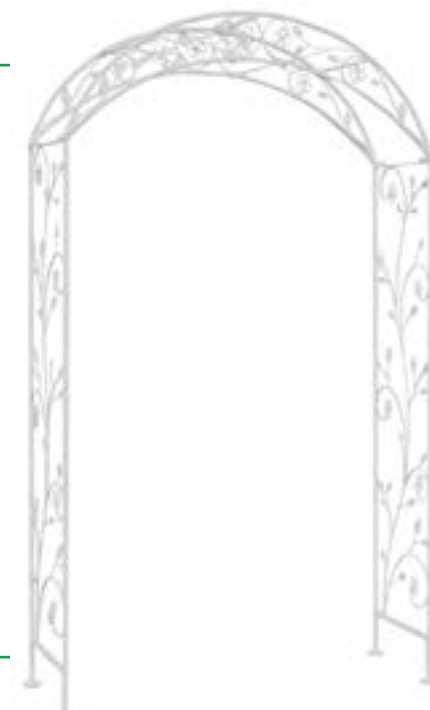

cm 135 x 47,5 x 230 h



1



Arco in metallo  
verniciato a polvere  
BIANCO  
trattamento elettroforesi



MF802631

**PANCA ANNETTE**

BIANCO ANTICO



8 056772 881639



cm 128 x 40 x 93 h



1



Panca in metallo  
verniciato a polvere  
BIANCO  
trattamento elettroforesi



MF802657

**SET/3 BISTRO' JEANETTE**

BIANCO ANTICO



8 056772 885040



T.cm62x73h /S.cm48x40x93h



1



Struttura in metallo verniciato a polvere  
set composto da 1 tavolo e 2 sedie  
BIANCO, trattamento elettroforesi



MF802632

**PANCA ELOISE**

BIANCO ANTICO



8 056772 881646



cm 136 x 46 x 96 h



1



Panca in metallo  
verniciato a polvere  
BIANCO  
trattamento elettroforesi



MF802658

**SET/3 BISTRO' ALISON**

BIANCO ANTICO



8 056772 885057



T. cm 60 x 72 h S. cm 36 x 35 x 91 h



1



Struttura in metallo verniciato a polvere  
e marmo, set composto da  
1 tavolo e 2 sedie  
BIANCO, trattamento elettroforesi





MF802701

**ÉTAGÈRE DOMINIQUE**

BIANCO OSSIDATO



cm 46 x 32 x 5,70 h



1



Étagère in metallo 3 piani  
verniciato a polvere  
BIANCO OSSIDATO  
trattamento elettroforesi

MF802695

**ÉTAGÈRE CHARLOTTE 4 PIANI**

BIANCO OSSIDATO



cm 49 x 35 x 154 h



1



Étagère in metallo 4 piani  
verniciato a polvere  
BIANCO OSSIDATO  
trattamento elettroforesi

MF802693

**ÉTAGÈRE FLORIANCE 4 PIANI**

BIANCO OSSIDATO



cm 60 x 31 x 60 x 158 h



1



Étagère in metallo 4 piani  
verniciato a polvere  
BIANCO OSSIDATO  
trattamento elettroforesi

MF802696

**ÉTAGÈRE CLAUDE 3 PIANI**

BIANCO OSSIDATO

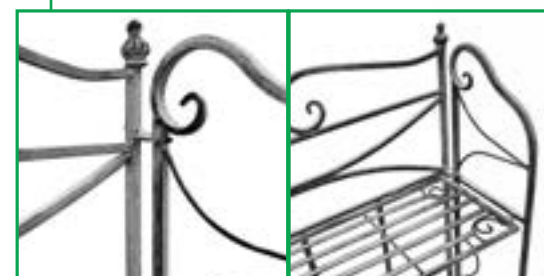

cm 61 x 32 x 117 h



1



Étagère in metallo 3 piani  
verniciato a polvere  
BIANCO OSSIDATO  
trattamento elettroforesi

MF802694

**ÉTAGÈRE NOELLE 4 PIANI**

BIANCO OSSIDATO



cm 61 x 32 x 156 h



1



Étagère in metallo 4 piani  
verniciato a polvere  
BIANCO OSSIDATO  
trattamento elettroforesi

MF802697

**ÉTAGÈRE ROSALIE 3 PIANI**

BIANCO OSSIDATO

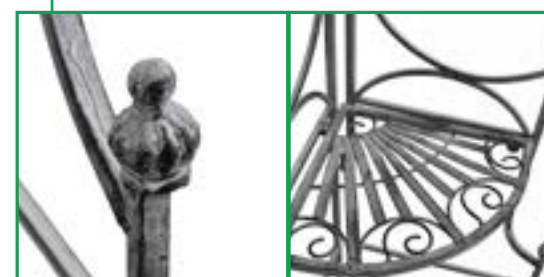

cm 49 x 35 x 115 h



1



Étagère in metallo 3 piani  
verniciato a polvere  
BIANCO OSSIDATO  
trattamento elettroforesi



MF802698

**ÉTAGÈRE SELENE**

BIANCO OSSIDATO



cm 60 x 32 x 128 h ↗

1

Étagère in metallo 3 piani  
verniciato a polvere  
BIANCO OSSIDATO  
trattamento elettroforesi

MF802699

**SET DI 3 FIORIERE VALERIE**

BIANCO OSSIDATO

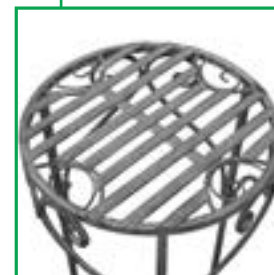

G.Ø32x72/M.Ø27x62/P.Ø22x52 ↗

1

Set di 3 stand in metallo  
verniciati a polvere  
BIANCO OSSIDATO  
trattamento elettroforesi

MF802708

**ÉTAGÈRE KIMBERLY**

BIANCO OSSIDATO

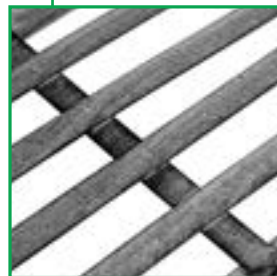

cm 37,5 x 51 x 81 h ↗

1

Étagère in metallo per fiori  
verniciato a polvere  
BIANCO OSSIDATO  
trattamento elettroforesi

MF802705

**ARCO ANDERSON**

BIANCO OSSIDATO

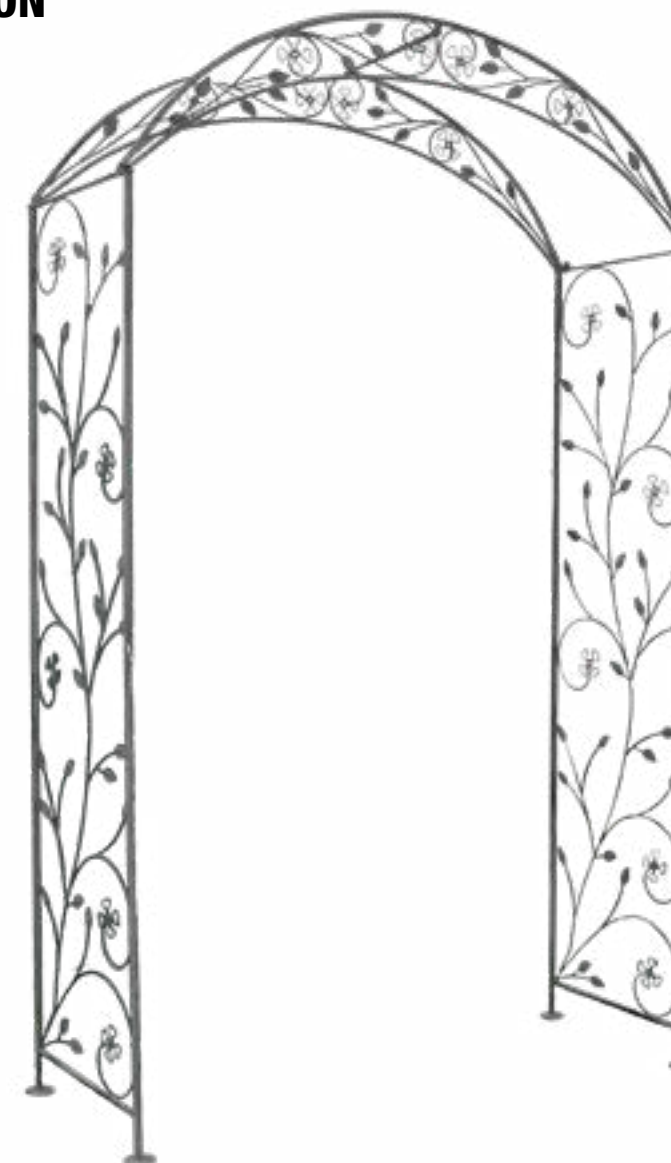

cm 135 x 47,5 x 230 h ↗

1

Arco in metallo  
verniciato a polvere  
BIANCO OSSIDATO  
trattamento elettroforesi

MF802700

**SET DI 3 FIORIERE VINCENT**

BIANCO OSSIDATO

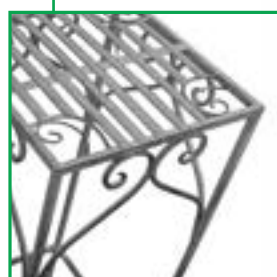

G.30x72/M.25x62/P.20x52 ↗

1

Set di 3 stand in metallo  
verniciati a polvere  
BIANCO OSSIDATO  
trattamento elettroforesi



MF802707

**SET/3 BISTRO' JEANETTE**

BIANCO OSSIDATO



T. cm 62 x 73 h S. cm 48 x 40 x 93 h

1

Struttura in metallo verniciato a polvere e marmo  
set composto da 1 tavolo e 2 sedie  
BIANCO OSSIDATO  
trattamento elettroforesi



MF802706

**PANCA DOLLIE**

BIANCO OSSIDATO



cm 103 x 54 x 95 h

1

Panca in metallo  
verniciato a polvere  
BIANCO OSSIDATO  
trattamento elettroforesi

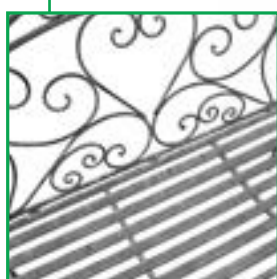

illuminazione





VL801600

**VASO LUMINOSO OCTANS 40 h  
CON LED MULTICOLOR A BATTERIA RICARICABILE  
TRAMITE PANNELLO SOLARE**

cm 40 x 40 x 40 h



1



Vaso con impianto luce a led a batteria ricaricabile lampada a led rgb lampadina fornita assemblata, azionabile con telecomando, classe III, ip44, 4w (g4) 12vdc kit batteria solare ricaricabile tramite pannello (max 8 ore) caricatore universale 230v-ip20 incluso

VL801601

**VASO LUMINOSO OCTANS 40 h CON CARICATORE  
ELETTRICO UNIVERSALE**

cm 40 x 40 x 40 h



1



Vaso con impianto luce a risparmio energetico Lampada a risparmio energetico 20w (e27) - 220/240v - 50/60 hz Cavo nero 3 m - Lampadina fornita assemblata - Protezione IP44

VL801602

**VASO LUMINOSO OCTANS 80 h  
CON LED MULTICOLOR A BATTERIA RICARICABILE  
TRAMITE PANNELLO SOLARE**

cm 40 x 40 x 80 h



1



Vaso con impianto luce a led a batteria ricaricabile lampada a led rgb lampadina fornita assemblata, azionabile con telecomando, classe III, ip44, 4w (g4) 12vdc kit batteria solare ricaricabile tramite pannello (max 8 ore) caricatore universale 230v-ip20 incluso

VL801603

**VASO LUMINOSO OCTANS 80 h CON CARICATORE  
ELETTRICO UNIVERSALE**

cm 40 x 40 x 80 h



1



Vaso con impianto luce a risparmio energetico Lampada a risparmio energetico 20w (e27) - 220/240v - 50/60 hz Cavo nero 3 m - Lampadina fornita assemblata - Protezione IP44





VL801608

**FIORIERA SCULPTOR 80 h  
CON LED MULTICOLOR E BATTERIA SOLARE  
TRAMITE PANNELLO SOLARE**

cm 90 x 30 x 80 h ↗

1



Sfera con impianto luce a led a batteria ricaricabile lampada a led rgb lampadina fornita assemblata, azionabile con telecomando, classe III, ip44, 4w (g4) 12vdc kit batteria solare ricaricabile tramite pannello (max 8 ore) caricatore universale 230v-ip20 incluso



VL801605

**FIORIERA SCULPTOR 80 h CON CARICATORE  
ELETTRICO UNIVERSALE**

cm 90 x 30 x 80 h ↗

1



Fioriera con impianto luce a risparmio energetico Lampada a risparmio energetico 20w (e27) - 220/240v - 50/60 hz Cavo nero 3 m - Lampadina fornita assemblata - Protezione IP44



VL801606

**FIORIERA SCULPTOR 50 h  
CON LED MULTICOLOR A BATTERIA RICARICABILE  
TRAMITE PANNELLO SOLARE**

cm 80 x 35 x 50 h ↗

1



Fioriera con impianto luce a led a batteria ricaricabile lampada a led rgb lampadina fornita assemblata, azionabile con telecomando, classe III, ip44, 4w (g4) 12vdc kit batteria solare ricaricabile tramite pannello (max 8 ore) caricatore universale 230v-ip20 incluso



VL801607

**FIORIERA SCULPTOR 50 h CON CARICATORE  
ELETTRICO UNIVERSALE**

cm 80 x 35 x 50 h ↗

1



Vaso con impianto luce a risparmio energetico Lampada a risparmio energetico 20w (e27) - 220/240v - 50/60 hz Cavo nero 3 m - Lampadina fornita assemblata - Protezione IP44





VL801604

**LAMPADA LUMINOSA ARIES 180 h CON CARICATORE  
ELETTRICO UNIVERSALE**

cm Ø 60 x 180 h ↗

1 



Lampada con impianto luce a risparmio energetico  
Lampada a risparmio energetico 20w (e27) - 220/240v - 50/60 hz  
Cavo nero 3 m - Lampadina fornita assemblata - Protezione IP44



VL801609

**SFERA LUMINOSA GEMINI Ø 50  
CON LED MULTICOLOR A BATTERIA RICARICABILE  
TRAMITE PANNELLO SOLARE**

cm Ø 50 ↗

1 



Sfera con impianto luce a led a batteria ricaricabile lampada a led rgb  
lampadina fornita assemblata, azionabile con telecomando, classe III, ip44, 4w (g4) 12vdc  
kit batteria solare ricaricabile tramite pannello (max 8 ore)  
caricatore universale 230v-ip20 incluso

VL801611

**SFERA LUMINOSA GEMINI Ø 50 CON CARICATORE  
ELETTRICO UNIVERSALE**

cm Ø 50 ↗

1 



Sfera con impianto luce a risparmio energetico  
Lampada a risparmio energetico 20w (e27) - 220/240v - 50/60 hz  
Cavo nero 3 m - Lampadina fornita assemblata - Protezione IP44

VL801610

**SFERA LUMINOSA GEMINI Ø 70  
CON LED MULTICOLOR A BATTERIA RICARICABILE  
TRAMITE PANNELLO SOLARE**

cm Ø 70 ↗

1 



Sfera con impianto luce a led a batteria ricaricabile lampada a led rgb  
lampadina fornita assemblata, azionabile con telecomando, classe III, ip44, 4w (g4) 12vdc  
kit batteria solare ricaricabile tramite pannello (max 8 ore)  
caricatore universale 230v-ip20 incluso

VL801612

**SFERA LUMINOSA GEMINI Ø 70 CON CARICATORE  
ELETTRICO UNIVERSALE**

cm Ø 70 ↗

1 



Sfera con impianto luce a risparmio energetico  
Lampada a risparmio energetico 20w (e27) - 220/240v - 50/60 hz  
Cavo nero 3 m - Lampadina fornita assemblata - Protezione IP44





VL801614

**VASO LUMINOSO HYDRA 70 h  
CON LED MULTICOLOR A BATTERIA RICARICABILE  
TRAMITE PANNELLO SOLARE**

cm Ø 33 x 70 h

1



Vaso con impianto luce a led a batteria ricaricabile lampada a led rgb lampadina fornita assemblata, azionabile con telecomando, classe III, ip44, 4w (g4) 12vdc kit batteria solare ricaricabile tramite pannello (max 8 ore) caricatore universale 230v-ip20 incluso

VL801613

**VASO LUMINOSO HYDRA 70 h CON CARICATORE  
ELETTRICO UNIVERSALE**

cm Ø 33 x 70 h

1



Vaso con impianto luce a risparmio energetico Lampada a risparmio energetico 20w (e27) - 220/240v - 50/60 hz Cavo nero 3 m - Lampadina fornita assemblata - Protezione IP44



VL801616

**VASO LUMINOSO HYDRA 90 h  
CON LED MULTICOLOR A BATTERIA RICARICABILE  
TRAMITE PANNELLO SOLARE**

cm Ø 40 x 90 h

1



Vaso con impianto luce a led a batteria ricaricabile lampada a led rgb lampadina fornita assemblata, azionabile con telecomando, classe III, ip44, 4w (g4) 12vdc kit batteria solare ricaricabile tramite pannello (max 8 ore) caricatore universale 230v-ip20 incluso

VL801615

**VASO LUMINOSO HYDRA 90 h CON CARICATORE  
ELETTRICO UNIVERSALE**

cm Ø 40 x 90 h

1



Vaso con impianto luce a risparmio energetico Lampada a risparmio energetico 20w (e27) - 220/240v - 50/60 hz Cavo nero 3 m - Lampadina fornita assemblata - Protezione IP44







VL801617

**VASO LUMINOSO HYDRUS 70 h  
CON LED MULTICOLOR A BATTERIA RICARICABILE  
TRAMITE PANNELLO SOLARE**

cm 33 x 33 x 70 h



1



Vaso con impianto luce a led a batteria ricaricabile lampada a led rgb lampadina fornita assemblata, azionabile con telecomando, classe III, ip44, 4w (g4) 12vdc kit batteria solare ricaricabile tramite pannello (max 8 ore) caricatore universale 230v-ip20 incluso



VL801618

**VASO LUMINOSO HYDRUS 70 h CON CARICATORE  
ELETTRICO UNIVERSALE**

cm 33 x 33 x 70 h



1



Vaso con impianto luce a risparmio energetico Lampada a risparmio energetico 20w (e27) - 220/240v - 50/60 hz Cavo nero 3 m - Lampadina fornita assemblata - Protezione IP44



VL801619

**VASO LUMINOSO HYDRUS 90 h  
CON LED MULTICOLOR A BATTERIA RICARICABILE  
TRAMITE PANNELLO SOLARE**

cm 40 x 40 x 90 h



1



Vaso con impianto luce a led a batteria ricaricabile lampada a led rgb lampadina fornita assemblata, azionabile con telecomando, classe III, ip44, 4w (g4) 12vdc kit batteria solare ricaricabile tramite pannello (max 8 ore) caricatore universale 230v-ip20 incluso



VL801620

**VASO LUMINOSO HYDRUS 90 h CON CARICATORE  
ELETTRICO UNIVERSALE**

cm 39 x 39 x 90 h



1



Vaso con impianto luce a risparmio energetico Lampada a risparmio energetico 20w (e27) - 220/240v - 50/60 hz Cavo nero 3 m - Lampadina fornita assemblata - Protezione IP44





VL801621

**VASO LUMINOSO DELPHINUS 50 h  
CON LED MULTICOLOR A BATTERIA RICARICABILE  
TRAMITE PANNELLO SOLARE**

cm Ø 40 x 50 h ↗

1 



Vaso con impianto luce a led a batteria ricaricabile lampada a led rgb  
lampadina fornita assemblata, azionabile con telecomando, classe III, ip44, 4w (g4) 12vdc  
kit batteria solare ricaricabile tramite pannello (max 8 ore)  
caricatore universale 230v-ip20 incluso

VL801622

**VASO LUMINOSO DELPHINUS 50 h CON CARICATORE  
ELETTRICO UNIVERSALE**

cm Ø 40 x 50 h ↗

1 



Vaso con impianto luce a risparmio energetico  
Lampada a risparmio energetico 20w (e27) - 220/240v - 50/60 hz  
Cavo nero 3 m - Lampadina fornita assemblata - Protezione IP44





VL801624

**CUBO 40 X 40 X 40 LUMINOSO INDUS  
CON LED MULTICOLOR A BATTERIA RICARICABILE  
TRAMITE PANNELLO SOLARE**

cm 40 x 40 x 90 h



1



Cubo con impianto luce a led a batteria ricaricabile lampada a led rgb lampadina fornita assemblata, azionabile con telecomando, classe III, ip44, 4w (g4) 12vdc kit batteria solare ricaricabile tramite pannello (max 8 ore) caricatore universale 230v-ip20 incluso

VL801623

**CUBO 40 X 40 X 40 LUMINOSO INDUS CON CARICATORE  
ELETTRICO UNIVERSALE**

cm 40 x 40 x 40 h



1



Cubo con impianto luce a risparmio energetico Lampada a risparmio energetico 20w (e27) - 220/240v - 50/60 hz Cavo nero 3 m - Lampadina fornita assemblata - Protezione IP44

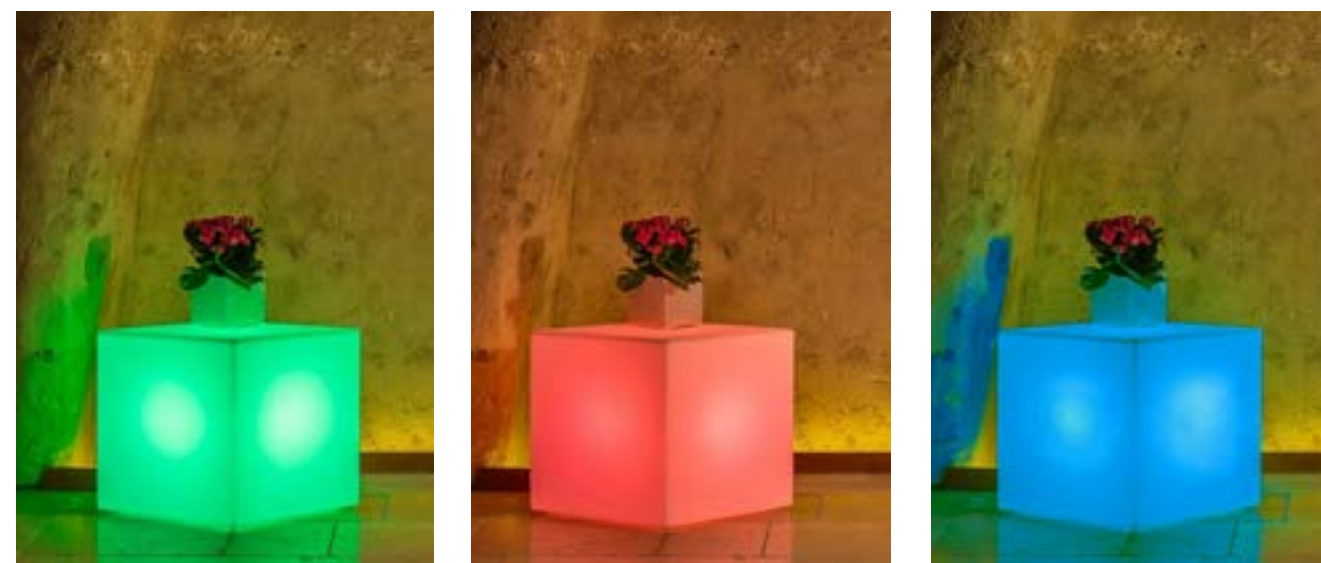

VL801625

**CUBO 40 X 40 X 80 LUMINOSO INDUS  
CON LED MULTICOLOR A BATTERIA RICARICABILE  
TRAMITE PANNELLO SOLARE**

cm 40 x 40 x 80 h



1



Cubo con impianto luce a led a batteria ricaricabile lampada a led rgb lampadina fornita assemblata, azionabile con telecomando, classe III, ip44, 4w (g4) 12vdc kit batteria solare ricaricabile tramite pannello (max 8 ore) caricatore universale 230v-ip20 incluso

VL801626

**CUBO 40 X 40 X 80 LUMINOSO INDUS CON CARICATORE  
ELETTRICO UNIVERSALE**

cm 40 x 40 x 80 h



1



Cubo con impianto luce a risparmio energetico Lampada a risparmio energetico 20w (e27) - 220/240v - 50/60 hz Cavo nero 3 m - Lampadina fornita assemblata - Protezione IP44

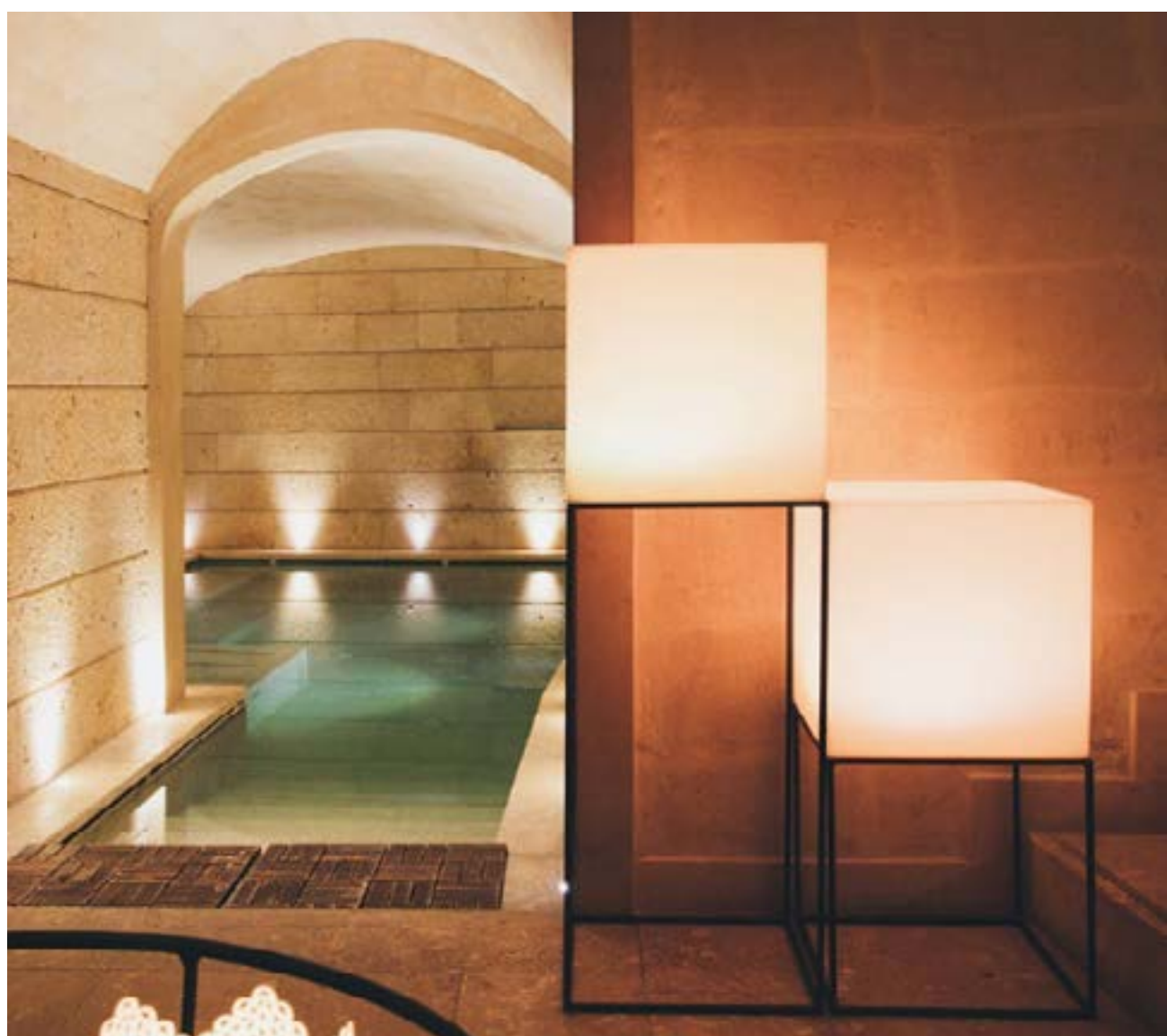





Vasi

VA801005-BEIG

## SET VASI TULIPANO

3 PEZZI, BEIGE



8 058265 840864



G.55x55x37  
M.42x42x29  
P.29x29x20

18

1

Set di 3 vasi  
in fibra d'argilla BEIGE

VA801005-DGRE

## SET VASI TULIPANO

3 PEZZI, GRIGIO SCURO



8 058265 840871



G.55x55x37  
M.42x42x29  
P.29x29x20

18

1

Set di 3 vasi  
in fibra d'argilla GRIGIO SCURO

VA801005-TAUP

## SET VASI TULIPANO

3 PEZZI, TAUPE



8 058265 840857



G.55x55x37  
M.42x42x29  
P.29x29x20

18

1

Set di 3 vasi  
in fibra d'argilla TAUPE



VA801036

**SET VASI GARDENIA**

4 PEZZI, GRIGIO



G.cm37x37x31,5h  
M.cm31x31x27,5h  
P.cm25x25x22,5h  
XS.cm19x19x17,5h



Set di 4 vasi  
in fibra sintetica

VA801039

**SET VASI MAGNOLIA**

3 PEZZI, VERDE OLIVA



G.cm43,5x43,5x78,5h  
M.cm34x34x63,5h  
P.cm24x24x49h



Set di 3 vasi  
in fibra sintetica

VA801037

**SET VASI ROSA**

4 PEZZI, VERDE OLIVA



G.cm37x37x31,5h  
M.cm31x31x27,5h  
P.cm25x25x22h  
XS.cm19x19x17,5h



Set di 4 vasi  
in fibra sintetica

VA801040

**SET VASI GERANEO**

4 PEZZI, GRIGIO VERDE



G.cm31x31x27,5h  
M.cm25x25x22h  
P.cm19x19x17,5h  
XS.cm37x37x31,5h



Set di 4 vasi  
in fibra sintetica

VA801038

**SET VASI PRIMULA**

4 PEZZI, TAUPE



G.cm44,5x44,5x43,5h  
M.cm37x37x34,5h  
P.cm31x31x31h  
XS.cm25,5x25,5x25,5h



Set di 4 vasi  
in fibra sintetica

VA801041

**SET VASI GLICINE**

3 PEZZI, GRIGIO VERDE



G.cm44x44x78,5h  
M.cm34x34x64h  
P.cm24x24x49h



Set di 3 vasi  
in fibra sintetica



VA801042

**SET VASI PESCO**

3 PEZZI, GRIGIO VERDE



8 051811 465764



G.cm44x44x43,5h  
M.cm37,5x37,5x35h  
P.cm31,5x31,5x30,5h



1



Set di 3 vasi  
in fibra sintetica

VA801045

**SET VASI GINEPRO**

3 PEZZI, GRIGIO



8 051811 465795



G.cm56x56x55h  
M.cm43,5x43,5x42,5h  
P.cm32x32x33,5h



1



Set di 3 vasi  
in fibra sintetica

VA801043

**SET VASI MUGHETTO**

3 PEZZI, GRIGIO



8 051811 465771



G.cm43,5x43,5x78,5h  
M.cm34x34x63,5h  
P.cm24x24x49h



1



Set di 4 vasi  
in fibra sintetica

VA801046

**SET VASI MALVA**

3 PEZZI, VERDE OLIVA



8 051811 465801



G.cm75x27x28h  
M.cm65x21x22,5h  
P.cm58x16x17,5h



1



Set di 3 vasi  
in fibra sintetica

VA801044

**SET VASI GAROFANO**

4 PEZZI, GRIGIO



8 051811 465788



G.cm44,5x44,5x43,5h  
M.cm37,5x37,5x35,5h  
P.cm31x31x31h  
XS.cm25,5x25,5x25,5h



1



Set di 4 vasi  
in fibra sintetica

VA801047

**SET VASI DAFNE**

2 PEZZI, GRIGIO CEMENTO



8 051811 465818



G.cm80x30,5x92h  
P.cm60x21x72h



1



Set di 2 vasi  
in fibra sintetica



VA801048

**SET VASI SAMBUCO**

4 PEZZI, GRIGIO



8 051811 465825



G.cm37x37x50,5h  
M.cm31x31x44h  
P.cm25x25x38h  
XS.cm19x19x33h



Set di 4 vasi  
in fibra sintetica

VA801008-BEIG

**SET VASI FIORDALISO**

3 PEZZI, BEIGE



8 058265 840956



G.47x47x75  
M.34x34x54  
P.24x24x39

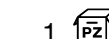
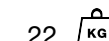

Set di 3 vasi  
in fibra d'argilla BEIGE

VA801049

**SET VASI VERBENA**

3 PEZZI, GRIGIO SCURO



8 051811 465832



G.cm50x50x50h  
M.cm40,5x40,5x41h  
P.cm31x31x31,5h



Set di 3 vasi  
in fibra sintetica

VA801008-DGRE

**SET VASI FIORDALISO**

3 PEZZI, GRIGIO SCURO



8 058265 840963



G.47x47x75  
M.34x34x54  
P.24x24x39

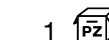
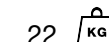

Set di 3 vasi  
in fibra d'argilla GRIGIO SCURO

VA801023

**SET VASI CRISANTEMO**

3 PEZZI, GRIGIO



8 058265 843315



G.43,5x43,5x78,5  
M.33,5x33,5x63,5  
P.23,5x23,5x48,5

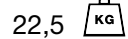

Set di 3 vasi  
in fibra d'argilla GRIGIA

VA801008-TAUP

**SET VASI FIORDALISO**

3 PEZZI, TAUPE



8 058265 840949



G.47x47x75  
M.34x34x54  
P.24x24x39

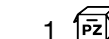
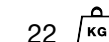

Set di 3 vasi  
in fibra d'argilla TAUPE



VA801006-BEIG

**SET VASI PEONIA**

4 PEZZI, BEIGE



G.57x57x57  
M.43,5x43,5x43,5  
P.31,5x31,5x31,5  
XS.20,5x20,5x20,5

27

1

Set di 4 vasi  
in fibra d'argilla BEIGE

VA801007-BEIG

**SET VASI PAPAVERO**

3 PEZZI, BEIGE



G.43,5x43,5x50  
M.35,5x35,5x41  
P.27x27x32

16,5

1

Set di 3 vasi  
in fibra d'argilla BEIGE

VA801006-DGRE

**SET VASI PEONIA**

4 PEZZI, GRIGIO SCURO



G.57x57x57  
M.43,5x43,5x43,5  
P.31,5x31,5x31,5  
XS.20,5x20,5x20,5

27

1

Set di 4 vasi  
in fibra d'argilla GRIGIO SCURO

VA801007-DGRE

**SET VASI PAPAVERO**

3 PEZZI, GRIGIO SCURO



G.43,5x43,5x50  
M.35,5x35,5x41  
P.27x27x32

16,5

1

Set di 3 vasi  
in fibra d'argilla GRIGIO SCURO

VA801006-TAUP

**SET VASI PEONIA**

4 PEZZI, TAUPE



G.57x57x57  
M.43,5x43,5x43,5  
P.31,5x31,5x31,5  
XS.20,5x20,5x20,5

39

1

Set di 4 vasi  
in fibra d'argilla TAUPE

VA801007-TAUP

**SET VASI PAPAVERO**

3 PEZZI, TAUPE



G.43,5x43,5x50  
M.35,5x35,5x41  
P.27x27x32

16,5

1

Set di 3 vasi  
in fibra d'argilla TAUPE



VA801024

**SET VASI DALIA**

4 PEZZI, GRIGIO



8 058265 843322



G.44x44x43  
M.37x37x35  
P.31x31x30,5  
XS.25,5x25,5x25

11,5

1

Set di 4 vasi  
in fibra d'argilla GRIGIA

VA801027

**SET VASI ORTENSIA**

3 PEZZI, GRIGIO



8 058265 843353



G.44x44x43,5  
M.37,5x37,5x35,5  
P.32x32x31,5

16,5

1

Set di 3 vasi  
in fibra d'argilla GRIGIA

VA801025

**SET VASI VIOLA**

3 PEZZI, GRIGIO



8 058265 843359



G.42,5x42,5x78,5  
M.33,5x33,5x61,5  
P.26,5x26,5x51

21,5

1

Set di 3 vasi  
in fibra d'argilla GRIGIA

VA801028

**SET VASI CALENDULA**

3 PEZZI, GRIGIO



8 058265 843360



G.44,5x44,5x44  
M.37,5x37,5x37  
P.31x31x30

39

1

Set di 3 vasi  
in fibra d'argilla GRIGIA

VA801026

**SET VASI LAVANDA**

3 PEZZI, GRIGIO



8 058265 843346



G.44x44x42,5  
M.37x37x36  
P.30,5x30,5x29,5

33,5

1

Set di 3 vasi  
in fibra d'argilla GRIGIO CHIARO

VA801029

**SET VASI CALLA 1**

3 PEZZI, GRIGIO



8 058265 843377



G.44,5x44,5x43  
M.37,5x37,5x36  
P.31,5x31,5x30,5

16,5

1

Set di 3 vasi  
in fibra d'argilla GRIGIA



VA801030

**SET VASI CALLA 2**

3 PEZZI, GRIGIO



G.44,5x44,5x43  
M.37,5x37,5x36  
P.31,5x31,5x30,5

16,5

1

Set di 3 vasi  
in fibra d'argilla GRIGIA

VA801033

**SET VASI GELSOMINO**

3 PEZZI, GRIGIO



G.43x43x78  
M.33,5x33,5x63  
P.23,5x23,5x47,5

22,8

1

Set di 3 vasi  
in fibra d'argilla GRIGIA

VA801031

**SET VASI TIGLIO**

3 PEZZI, GRIGIO



G.43,5x43,5x78,5/  
M.33,5x33,5x63,5/  
P.23,5x23,5x48,5

22,5

1

Set di 3 vasi  
in fibra d'argilla GRIGIA

VA801034

**SET VASI BEGONIA**

3 PEZZI, GRIGIO



G.43x43x78  
M.33,5x33,5x63  
P.23,5x23,5x48,5

22,5

1

Set di 3 vasi  
in fibra d'argilla GRIGIA

VA801032

**SET VASI MIMOSA**

3 PEZZI, GRIGIO



G.44,5x44,5x44  
M.37x37x35,5  
P.31x31x31

16,5

1

Set di 3 vasi  
in fibra d'argilla GRIGIA

VA801035

**SET VASI OLEANDRO**

3 PEZZI, GRIGIO



G.43,5x43,5x78,5  
M.33,5x33,5x63,5  
P.23,5x23,5x48,5

22,5

1

Set di 3 vasi  
in fibra d'argilla GRIGIA



VA801004-BEIG

**SET VASI GIGLIO**

4 PEZZI, BEIGE



G.42x42x88/  
M.32x32x65,5/  
P.23,5x23,5x50,5/  
XS.18x18x38

33,5

1

Set di 4 vasi  
in fibra d'argilla BEIGE

VA801004-DGRE

**SET VASI GIGLIO**

4 PEZZI, GRIGIO SCURO



G.42x42x88/  
M.32x32x65,5/  
P.23,5x23,5x50,5/  
XS.18x18x38

33,5

1

Set di 4 vasi  
in fibra d'argilla GRIGIO SCURO

VA801004-LGRE

**SET VASI GIGLIO**

4 PEZZI, GRIGIO CHIARO



G.42x42x88/  
M.32x32x65,5/  
P.23,5x23,5x50,5/  
XS.18x18x38

33,5

1

Set di 4 vasi  
in fibra d'argilla GRIGIO CHIARO

VA801001-BEIG

**SET VASI ORCHIDEA**

4 PEZZI, BEIGE



G.54,5x54,5x100,5  
M.42x42x78  
P.32,5x32,5x62  
XS.23,5x23,5x46

39

1

Set di 4 vasi  
in fibra d'argilla BEIGE

VA801001-GREY

**SET VASI ORCHIDEA**

4 PEZZI, GRIGIO



G.54,5x54,5x100,5  
M.42x42x78  
P.32,5x32,5x62  
XS.23,5x23,5x46

39

1

Set di 4 vasi  
in fibra d'argilla GRIGIO

VA801001-MRNE

**SET VASI ORCHIDEA**

4 PEZZI, MARRONE



G.54,5x54,5x100,5  
M.42x42x78  
P.32,5x32,5x62  
XS.23,5x23,5x46

39

1

Set di 4 vasi  
in fibra d'argilla MARRONE



VA801002 BEIG

**SET VASI MARGHERITA**

4 PEZZI, BEIGE



G.43x43x89/  
M.32x32x65/  
P.24,5x24,5x50,5/  
XS.18,5x18,5x38,5

31

1

Set di 4 vasi  
in fibra d'argilla BEIGE

VA801002-GREY

**SET VASI MARGHERITA**

4 PEZZI, GRIGIO



G.43x43x89/  
M.32x32x65/  
P.24,5x24,5x50,5/  
XS.18,5x18,5x38,5

31

1

Set di 4 vasi  
in fibra d'argilla GRIGIO

VA801002-MRNE

**SET VASI MARGHERITA**

4 PEZZI, MARRONE



G.43x43x89/  
M.32x32x65/  
P.24,5x24,5x50,5/  
XS.18,5x18,5x38,5

31

1

Set di 4 vasi  
in fibra d'argilla MARRONE

VA801003-BEIG

**SET VASI CICLAMINO**

3 PEZZI, BEIGE



G.44x44x39/  
M.35x35x30,5/  
P.27,5x27,5x24,5

13

1

Set di 3 vasi  
in fibra d'argilla BEIGE

VA801003-DGRE

**SET VASI CICLAMINO**

3 PEZZI, GRIGIO SCURO



G.44x44x39/  
M.35x35x30,5/  
P.27,5x27,5x24,5

13

1

Set di 3 vasi  
in fibra d'argilla GRIGIO SCURO

VA801003-LGRE

**SET VASI CICLAMINO**

3 PEZZI, GRIGIO CHIARO



G.44x44x39/  
M.35x35x30,5/  
P.27,5x27,5x24,5

13

1

Set di 3 vasi  
in fibra d'argilla GRIGIO CHIARO



VA801050

**VASO PICCOLO GIRASOLE**

1 PEZZO, BIANCO ANTICATO



8 051811 465849



cm 13,5 x 13,5 x 12 h



in fibra sintetica

VA801053

**VASO PICCOLO BUCANEVE**

1 PEZZO, GRIGIO SCURO



8 051811 465870



cm 13 x 13 x 11,5 h



in fibra sintetica

VA801051

**VASO MEDIO GIRASOLE**

1 PEZZO, BIANCO ANTICATO



8 051811 465856



cm 17 x 17 x 14,5 h



in fibra sintetica

VA801054

**VASO MEDIO BUCANEVE**

1 PEZZO, GRIGIO SCURO



8 051811 465887



cm 15,5 x 15,5 x 14 h



in fibra sintetica

VA801052

**VASO GRANDE GIRASOLE**

1 PEZZO, BIANCO ANTICATO



8 051811 465863



cm 20,7 x 20,7 x 17 h



in fibra sintetica

VA801055

**VASO GRANDE BUCANEVE**

1 PEZZO, GRIGIO SCURO



8 051811 465894



cm 17,8 x 17,8 x 16 h



in fibra sintetica



VA801056

**VASO PICCOLO PANSÈ**

1 PEZZO, MARRONE



8 051811 465900



cm 13 x 13 x 11,5 h



in fibra sintetica

VA801059

**VASO PICCOLO MELISSA**

1 PEZZO, GRIGIO SCURO



8 051811 465931



cm 12,7 x 12,7 x 11,7 h



in fibra sintetica

VA801057

**VASO MEDIO PANSE'**

1 PEZZO, MARRONE



8 051811 465917



cm 15,5 x 15,5 x 14



in fibra sintetica

VA801060

**VASO MEDEIO MELISSA**

1 PEZZO, GRIGIO SCURO



8 051811 465948



cm 15,3 x 15,3 x 14 h



in fibra sintetica

VA801058

**VASO GRANDE PANSE'**

1 PEZZO, MARRONE



8 051811 465924



cm 18,2 x 18,2 x 16,2 h



in fibra sintetica

VA801061

**VASO GRANDE MELISSA**

1 PEZZO, GRIGIO SCURO



8 051811 465955



cm 18 x 18 x 16 h



in fibra sintetica



VA801062

**VASO PICCOLO BETULLA**

1 PEZZO, TORTORA



cm 16 x 16 x 14,5 h



in fibra sintetica

VA801009-BIAN

**VASO PICCOLO NARCISO**

BIANCO



VA801009-ANTR

ANTRACITE



VA801009-TAUPE

TAUPE



cm Ø 25 x 18,5

0,7 kg

8 pz

vaso in resina  
bianco antracite o taupe

VA801063

**VASO MEDIO BETULLA**

1 PEZZO, TORTORA



cm 18,8 x 18,8 x 16,5 h



in fibra sintetica

VA801010-BIAN

**VASO MEDIO NARCISO**

BIANCO



VA801010-ANTR

ANTRACITE



VA801010-TAUPE

TAUPE



cm Ø 39 x 28

2,8 kg

5 pz

vaso in resina  
bianco antracite o taupe

VA801064

**VASO GRANDE BETULLA**

1 PEZZO, TORTORA



cm 23 x 23 x 19 h



in fibra sintetica

VA801011-BIAN

**VASO GRANDE NARCISO**

BIANCO



VA801011-ANTR

ANTRACITE



VA801011-TAUPE

TAUPE



cm Ø 45 x 32

3 kg

3 pz

vaso in resina  
bianco antracite o taupe



VA801012-BIAN

**VASO PICCOLO IRIS**

BIANCO



cm Ø 19 x 22

0,6

40

vaso in resina  
bianco antracite o taupe

VA801012-ANTR

ANTRACITE



VA801012-TAUP

TAUPE



VA801013-BIAN

**VASO MEDIO IRIS**

BIANCO



cm Ø 29 x 36

1,6

5

vaso in resina  
bianco antracite o taupe

VA801013-ANTR

ANTRACITE



VA801013-TAUP

TAUPE



VA801014-BIAN

**VASO GRANDE IRIS**

BIANCO



cm Ø 39 x 46

3,1

4

vaso in resina  
bianco antracite o taupe

VA801014-ANTR

ANTRACITE



VA801014-TAUP

TAUPE



VA801015-BIAN

**VASO PICCOLO CAMELIA**

BIANCO



cm Ø 31 x 25,4

1,8

8

vaso in resina  
bianco antracite o taupe

VA801015-ANTR

ANTRACITE



VA801015-TAUP

TAUPE



VA801016-BIAN

**VASO MEDIO CAMELIA**

BIANCO



cm Ø 35 x 33

2

6

vaso in resina  
bianco antracite o taupe

VA801016-ANTR

ANTRACITE



VA801016-TAUP

TAUPE



VA801017-BIAN

**VASO GRANDE CAMELIA**

BIANCO



cm Ø 41 x 33,3

3,6

6

vaso in resina  
bianco antracite o taupe

VA801017-ANTR

ANTRACITE



VA801017-TAUP

TAUPE





VA801020-BIAN

**VASO PICCOLO ANEMONE**

**BIANCO**



cm Ø 25,5 x 32,5

1,7

5

vaso in resina  
bianco antracite o taupe

VA801020-ANTR

**ANTRACITE**



VA801020-TAUP

**TAUPE**



VA801018-BIAN

**VASO PICCOLO AZALEA**

**BIANCO**



cm Ø 31 x 46

2,5

3

vaso in resina  
bianco antracite o taupe

VA801018-ANTR

**ANTRACITE**



VA801018-TAUP

**TAUPE**



VA801021-BIAN

**VASO MEDIO ANEMONE**

**BIANCO**



cm Ø 29 x 36

2

5

vaso in resina  
bianco antracite o taupe

VA801021-ANTR

**ANTRACITE**



VA801021-TAUP

**TAUPE**



VA801019-BIAN

**VASO GRANDE AZALEA**

**BIANCO**



cm Ø 41 x 60

6,2

84

vaso in resina  
bianco antracite o taupe

VA801019-ANTR

**ANTRACITE**



VA801019-TAUP

**TAUPE**



VA801022-BIAN

**VASO GRANDE ANEMONE**

**BIANCO**



cm Ø 39 x 46

3,7

3

vaso in resina  
bianco antracite o taupe

VA801022-ANTR

**ANTRACITE**



VA801022-TAUP

**TAUPE**







Panche in ghisa e legno

GH801013

## PANCA GHISA LION



cm 130 x 56 x 72 h

23

1

Panca in ghisa e legno 12 stecche

GH801012

## PANCA GHISA REAL



cm 126 x 60 x 77 h

25

1

Panca in ghisa e legno 12 stecche

GH801011

## PANCA GHISA GINEVRA



cm 126 x 53 x 73 h

22,5

1

Panca in ghisa e legno 7 stecche





Articoli in legno di pino

PIBD02455

## PERGOLA 300 X 300



8 053251 680271



cm 300 X 300 X 250 h ↗

23,5 

1 

Pino impregnato in autoclave 

PIBD02459

## LEGNAIA 180 X 66 X 152/177



8 053251 680518



cm 180 x 60 x 152/177 h ↗

7,8 

1 

Pino impregnato in autoclave 



PIBD02454

**PERGOLA AD ARCO 160 X 70 X 190 CON PANCA**



cm 160 x 70 x 190 h ↗

16,9

1

Pino impregnato in autoclave

PIBD02472

**FRANGIVENTO LILO ECO 180 X 180**



cm 180 x 180 ↗

6,3

1

Pino impregnato in autoclave

PIBD02458

**LEGNAIA 217 X 80 X 155/180**



cm 217 x 80 x 155/180 h ↗

14,5

1

Pino impregnato in autoclave

PIBD02465

**FRANGIVENTO LILO 90x180**



cm 90 x 180 ↗

3,3

1

Pino impregnato in autoclave

PIBD02466

**FRANGIVENTO LILO 120x180**



cm 120 x 180 ↗

4,5

1

Pino impregnato in autoclave



PIBD10823

**CANCELLO 100 X 100**



cm 100 x 100 ↗  
2,3   
1   
Pino impregnato in autoclave

PIBD17624

**RECINTO 180 X 100**



cm 180 x 100 ↗  
3,2   
1   
Pino impregnato in autoclave

PIBD02468

**RECINTO INGLESE 110 X 3,2 X 28/45**

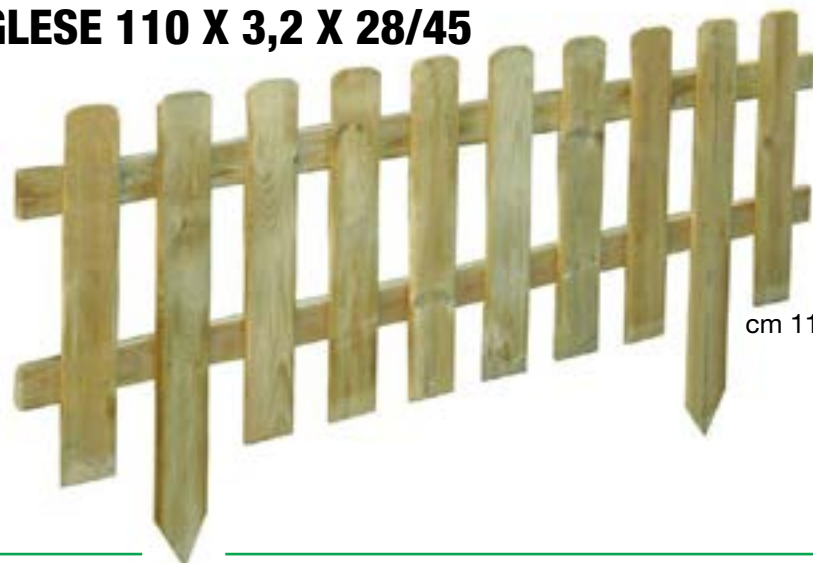

cm 110 x 3,2 x 28/45 h ↗  
1,5   
1   
Pino impregnato in autoclave

PIBD02463

**GRIGLIA ARCO 90 X 180**



cm 90 x 180 ↗  
6,3   
1   
Pino impregnato in autoclave

PIBD02262

**GRIGLIA SANDRA 120 X 180**



cm 120 x 10 ↗  
6,3   
1   
Pino impregnato in autoclave



PIBD02451  
**GRIGLIA SANDRA 40 X 180**



cm 40 x 180

1,1

1

Pino impregnato  
in autoclave

PIBD02237  
**GRIGLIA SANDRA 90 X 180**



cm 90 x 180

1,8

1

Pino impregnato  
in autoclave

PIBD02467  
**GRIGLIA SANDRA 60 X 180**



cm 60 x 180

1,1

1

Pino impregnato  
in autoclave

PIBD02452  
**GRIGLIA SANDRA 90 X 90**



cm 90 x 90

1,1

1

Pino impregnato  
in autoclave

PIBD02462  
**PIEDINO DOPPIO SOSTEGNO**  
PER GRIGLIA 60 x 4,5 x 30 cm

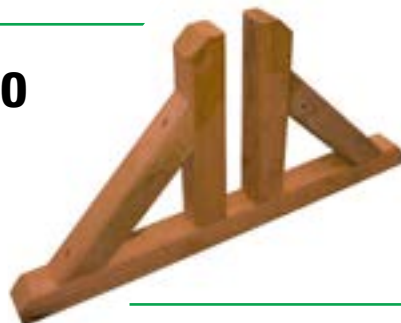

cm 60 x 4,5 x 30 h

1,2

1

Pino impregnato in autoclave

PIBD02453  
**FIORIERA 30 X 75 X 30 CON GRIGLIA 180**



cm 30 x 75 x 180 h

4,1

1

Pino impregnato in autoclave

PIBD02456  
**FIORIERA 40x40x40**



cm 40 x 40 x 40 h

2,7

1

Pino impregnato in autoclave

PIBD02457  
**FIORIERA 40x80x40**



cm 40 x 80 x 40h

4,2

1

Pino impregnato in autoclave



PIBD02460

**TAVOLO DA PIC NIC 200 X 148 X 70**



cm 200 x 148 x 70 h ↗

21

1

Pino impregnato in autoclave

PIBD15543

**CASSAPANCA PINO 75**



cm 75 x 35 x 33 h ↗

Pino

PIBD15544

**CASSAPANCA PINO 100**



cm 100 x 40 x 50 h ↗

Pino

PIBD02471

**TAVOLO DA PIC NIC 180 X 160 X 71**



cm 180 X 160 X 70 h ↗

13,5

1

Pino naturale



AL806849

**CASSETTA IN LEGNO FIONA**



8 051811 468147



cm 270 x 192 x 196 h

358

1

Casetta in legno

AL806850

**CASSETTA IN LEGNO ANASTASIA**



8 051811 468154



cm 258 x 255 x 231 h

400

1

Casetta in legno

AL806851

**CASSETTA IN LEGNO ESMERALDA**



8 051811 468161



cm 223 x 221 x 230 h

438

1

Casetta in legno



AL806828

**CASSETTA IN LEGNO HEIDI**



8 051811 462466



cm 112 x 126 x 158 h ↗

116

1

Casetta in legno

AL806830

**CASSETTA IN LEGNO POLLON CON SCIVOLO**



8 051811 462480



cm 174 x 155 x 212 h ↗

195,0

1

Casetta in legno con scivolo

AL806829

**CASSETTA IN LEGNO POLLON**



8 051811 462473



cm 174 x 155 x 212 h ↗

195,0

1

Casetta in legno

AL806831

**CASSETTA IN LEGNO MASHA**



8 051811 462497



cm 220 x 174 x 250 h ↗

323

1

Casetta in legno



AL806832

**CASSETTA IN LEGNO MASHA CON SCIVOLO**



cm 220 x 174 x 250 h

323

1

Casetta in legno con scivolo

AL806834

**CASSETTA IN LEGNO DOREMI**



cm 176 x 176 x 273 h

354

1

Casetta in legno

AL806833

**CASSETTA IN LEGNO MAIA**



cm 161 x 248 x 218 h

430

1

Casetta in legno

AL806835

**CASSETTA IN LEGNO DOREMI CON SCIVOLI**



cm 176 x 176 x 273 h

376

1

Casetta in legno con scivoli



HA809055-MRNE

**CASSETTA HOME**

MARRONE



8 05 18 11 46 13 39



cm 134 x 192 x 204 h

1



Casetta in plastica con finestra



HA809056-MRNE

**CASSETTA HOME**

MARRONE



8 05 18 11 46 13 53



cm 190 x 192 x 226 h

1



Casetta in plastica con finestra



HA809055-LGRE

**CASSETTA HOME**

GRIGIO



8 05 18 11 46 13 46



cm 134 x 192 x 204 h

1



Casetta in plastica con finestra



HA809056-LGRE

**CASSETTA HOME**

GRIGIO



8 05 18 11 46 13 60



cm 190 x 192 x 226 h

1



Casetta in plastica con finestra





HA809057-MRNE

**CASSETTA HOUSE**

MARRONE



cm 111 x 191 x 194 h

1

Casetta in plastica con finestra

HA809058-MRNE

**CASSETTA HOUSE**

MARRONE



cm 143 x 247 x 194 h

1

Casetta in plastica con finestra

HA809057-LGRE

**CASSETTA HOUSE**

GRIGIO



cm 111 x 191 x 194 h

1

Casetta in plastica con finestra

HA809058-LGRE

**CASSETTA HOUSE**

GRIGIO



cm 143 x 247 x 194 h

1

Casetta in plastica con finestra



HA809059-MRNE

**CASSETTA MAISON**

MARRONE



cm 191 x 111 x 194 h

1

Casetta in plastica con finestra

HA809061-MRNE

**PANNELLO FENCING**

MARRONE



cm 150 x 120 h

1

Pannello in plastica

HA809059-LGRE

**CASSETTA MAISON**

GRIGIO



cm 191 x 111 x 194 h

1

Casetta in plastica con finestra

HA809061-LGRE

**PANNELLO FENCING**

GRIGIO



cm 150 x 120 h

1

Pannello in plastica



HA809060-MRNE

**BAULE TRUNK**

MARRONE



cm 152 x 70 x 70 h  
1   
Baule in plastica

HA809060-LGRE

**BAULE TRUNK**

GRIGIO



cm 152 x 70 x 70 h  
1   
Baule in plastica

HA809053-ANTR

**CASSAPANCA RATTAN STYLE**

ANTRACITE



cm 116 x 56 x 58 h  
1   
200 Kg  
Struttura in plastica, wicker  
ANTRACITE seduta con portata 200KG

HA809053-MRNE

**CASSAPANCA RATTAN STYLE**

MARRONE



cm 116 x 56 x 58 h  
1   
200 Kg  
Struttura in plastica, wicker  
MARRONE seduta con portata 200KG

HA809054-MRNE

**CASSAPANCA RATTAN STYLE XXL**

MARRONE



cm 157,5 x 75 x 63,5 h  
1   
200 Kg  
Struttura in plastica wicker  
MARRONE

HA809054-ANTR

**CASSAPANCA RATTAN STYLE XXL**

ANTRACITE



cm 157,5 x 75 x 63,5 h  
1   
200 Kg  
Struttura in plastica wicker  
ANTRACITE

DH802510

**CUCCIA CHARLIE**



cm 86 x 84 x 82 h  
---   
1   
Cuccia per cane  
in plastica marrone

DH802511-MRNE

**CUCCIA PLUTO**

MARRONE



cm 72 x 71,5 x 68 h  
2   
1   
Cuccia per cane  
in plastica MARRONE





SS809869

**TAPPETO SINTETICO 0,7 CM  
(1x25M)**



m 1x25 ↗

1 📦

Tappeto sintetico in rotolo  
altezza fili d'erba 0,7 cm



SS809868

**TAPPETO SINTETICO 0,7 CM  
(2x25M)**



m 2x25 ↗

1 📦

Tappeto sintetico in rotolo  
altezza fili d'erba 0,7 cm



SS809860

**TAPPETO SINTETICO 2 CM  
(1X25M)**



m 1x25 ↗

1 📦

Tappeto sintetico  
in rotolo, 4 toni  
altezza fili d'erba 2 cm



SS809861

**TAPPETO SINTETICO 2 CM  
(2X25M)**



m 2x25 ↗

1 📦

Tappeto sintetico  
in rotolo, 4 toni  
altezza fili d'erba 2 cm



## Tappeti e siepi



SS809862  
**TAPPETO SINTETICO 3 CM**  
**(1X25M)**



m 1x25 ↗

1 📦

Tappeto sintetico  
in rotolo, 4 toni  
altezza fili d'erba 3 cm

SS809863  
**TAPPETO SINTETICO 3 CM**  
**(2X25M)**



m 2x25 ↗

1 📦

Tappeto sintetico  
in rotolo, 4 toni  
altezza fili d'erba 3 cm

SS809824  
**TAPPETO SINTETICO 4 CM**  
**(1X25M)**



m 1x25 ↗

1 📦

Tappeto sintetico  
in rotolo, 4 toni  
altezza fili d'erba 4 cm

SS809821  
**TAPPETO SINTETICO 4 CM**  
**(2X25M)**



m 2x25 ↗

1 📦

Tappeto sintetico  
in rotolo, 4 toni  
altezza fili d'erba 4 cm

SS809852  
**SIEPE SINTETICA PINO 100 X 300**



cm 300 x 100 h ↗

3,4 📦

4 📦

Siepe sintetica  
in rotolo

SS809853  
**SIEPE SINTETICA PINO 150 X 300**



cm 300 x 150 h ↗

3,4 📦

4 📦

Siepe sintetica  
in rotolo

SS809835  
**SIEPE SINTETICA PESCA**  
**100x300**



cm 100x300 h ↗

2,3 📦

4 📦

Rotolo con rete ombreggiante di siepe  
in polietilene

SS809813  
**SIEPE SINTETICA PESCA**  
**150x300**



cm 150x300 h ↗

3,4 📦

4 📦

Rotolo con rete ombreggiante di siepe  
in polietilene



SS809829

**SIEPE SINTETICA PESCA**

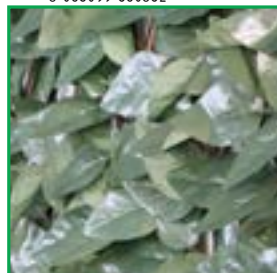

cm 100x200 h

2,2

4

Estensibile in legno con siepe  
in polietilene, borsa in pvc

SS809830

**SIEPE SINTETICA ACERO**



cm 100x200 h

2,3

4

Estensibile in legno con siepe  
in polietilene, borsa in pvc

SS809831

**SIEPE SINTETICA PITOSFORO**



cm 100x200 h

4,3

4

Estensibile in bambu con siepe  
in polietilene con borsa pvc

SS809832

**SIEPE SINTETICA PHOTINIA**

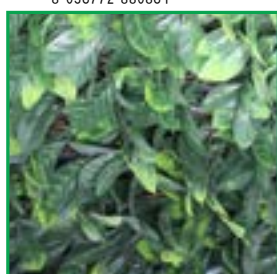

cm 100x120 h

3,8

4

Estensibile in legno con siepe  
in polietilene con borsa pvc



Funghi a gas e barbecue



BQ804094-BIANCO

**FUNGO A GAS**

BIANCO



↗ Base cm Ø 46 x 86h  
h. totale 220cm

KG 22

PZ 1

⌘ Struttura in acciaio verniciato a polvere  
flusso 450gr - 870gr all'ora  
funziona con propano e butano  
bruciatore cm Ø 27,5x53 h  
potenza 5000-13000W



BQ804094-LGRE

**FUNGO A GAS**

GRIGIO CHIARO



↗ Base cm Ø 46 x 86h  
h. totale 220cm

KG 22

PZ 1

⌘ Struttura in acciaio verniciato a polvere  
flusso 450gr - 870gr all'ora  
funziona con propano e butano  
bruciatore cm Ø 27,5x53 h  
potenza 5000-13000W



BQ804094-DGRE

**FUNGO A GAS**

GRIGIO SCURO



↗ Base cm Ø 46 x 86h  
h. totale 220cm

KG 22

PZ 1

⌘ Struttura in acciaio verniciato a polvere  
flusso 450gr - 870gr all'ora  
funziona con propano e butano  
bruciatore cm Ø 27,5x53 h  
potenza 5000-13000W



BQ804094-NAT

**FUNGO A GAS**

ACCIAIO



↗ Base cm Ø 46 x 86h  
h. totale 220cm

KG 22

PZ 1

⌘ Struttura in acciaio  
flusso 450gr - 870gr all'ora  
funziona con propano e butano  
bruciatore cm Ø 27,5x53 h  
potenza 5000-13000W



BQ804107

**BARBECUE TEXAS**

3 FUOCHI + 1



cm 133,5 x 52 x 114,5 h

44 KG

1 PZ

Barbeque in acciaio inox 3+1 fuochi  
2 griglie in ghisa + 1 piastra in ghisa, piano cottura 64x44cm  
con fornello laterale e vaschetta di sgocciamento

BQ804108

**BARBECUE TEXAS**

4 FUOCHI + 1



cm 144,5 x 58 x 114,5 h

54 KG

1 PZ

Barbeque in acciaio inox 4+1 fuochi  
1 griglia in ghisa + 1 piastra in ghisa, piano cottura 74x44cm  
con fornello laterale e vaschetta di sgocciamento



BQ804111  
**BARBECUE MONTANA**

5 FUOCHI + 1



Area Grill 79 x 41 cm



Ganci laterali



T. fino a 425°C

cm 144 x 57 x 114 h

47

1

Barbecue in acciaio inox 5 +1 fuochi  
Griglie con tondino in acciaio  
Fornello laterale e vaschetta di sgocciolamento

BQ804109  
**BARBECUE MONTANA**

3 FUOCHI + 1



Area Grill 59 x 41 cm



Ganci laterali



T. fino a 425°C

cm 120 x 57 x 114 h

35

1

Barbecue in acciaio inox 3 + 1 fuochi  
Griglie con tondino in acciaio  
Fornello laterale e vaschetta di sgocciolamento

BQ804110  
**BARBECUE MONTANA**

4 FUOCHI + 1



Area Grill 69 x 41 cm



Ganci laterali



T. fino a 425°C

cm 133 x 57 x 114 h

42

1

Barbecue in acciaio inox 4 +1 fuochi  
Griglie con tondino in acciaio  
Fornello laterale e vaschetta di sgocciolamento

BQ804105  
**BARBECUE DAVIS**

5 FUOCHI + 1



Area Grill 73,5 x 39 cm  
+ 73,5 x 12,5 cm



cm 138 x 55,5 x 112 h

41

1

Barbeque in acciaio inox , griglia di cottura in acciaio inox 5F + 1 fornello laterale  
Accensione automatica 5 bruciatori in acciaio inox 2.7 kw, 1 bruciatore laterale in acciaio inox 2.5 kw



BQ804104

**BARBECUE DAVIS**

4 FUOCHI + 1



Area Grill 63,5 x 39 cm  
+ 63,5 x 12,5 cm

cm 128,5 x 55,5 x 112 h

35

1

Barbeque in acciaio inox, griglia di cottura in acciaio inox 4F + 1 fornello laterale accensione automatica, 4 bruciatori in acciaio inox 2.7 kw, 1 bruciatore laterale in acciaio inox 2.5 kw

BQ804106

**BARBECUE A CARBONELLA AUSTIN**



cm 118 x 56 x 110 h

29

1

Struttura in acciaio verniciato NERO

fornito di 2 griglie, ganci porta posate, apribottiglia ripiano laterale in acciaio pieghevole coperchio con regolazione della temperatura area grill 56 x 41,5 cm

BQ804103

**BARBECUE DAVIS**

3 FUOCHI + 1



Area Grill 52 x 39 cm  
+ 52 x 12,5 cm



cm 117 x 55,5 x 112 h

37

1

Barbeque in acciaio inox, griglia di cottura in acciaio inox 3F +1 fornello laterale accensione automatica, 3 bruciatori in acciaio inox 2.7 kw, 1 bruciatore laterale in acciaio inox 2.5 kw

BQ804146

**BARBECUE A CARBONELLA AUSTIN XXL**



cm 160 x 65 x 107,5 h

33

1

Struttura in acciaio verniciato NERO

fornito di 2 griglie, ganci porta posate, apribottiglia ripiano laterale in acciaio pieghevole coperchio con regolazione della temperatura



BQ804149

**BARBECUE A CARBONELLA TENNESSEE**



8 051811 467225



cm 113 x 70 x 97,5 cm

25

1

Struttura in acciaio verniciato NERO

fornito di 2 griglie,  
coperchio e termometro

BQ804118

**BARBECUE WISCONSIN  
A CARBONELLA**



8 058265 848518



cm 100 x 47 x 94 h

19,5

1

Struttura in acciaio verniciato NERO  
con 2 griglie regolabili in altezza

BQ804119

**BARBECUE KENTUCKY  
A CARBONELLA CON AFFUMICATORE**



8 058265 848525



cm 110 x 64 x 113,5 h

17

1

Struttura in acciaio verniciato  
NERO

**ACCESSORI PER BARBECUE TEXAS**

BQ804144 SPARGIFIAMMA PER BARBECUE TEXAS

8 051811 460998

BQ804145 BRUCIATORE PER BARBECUE TEXAS

8 051811 461001

BQ804031-3F GRIGLIA GHISA 21,3 x 44 cm PER BARBECUE TEXAS 3 FUOCHI+1

8 033695 765376

BQ804031-4F GRIGLIA GHISA 37 x 44 cm PER BARBECUE TEXAS 4 FUOCHI+1

8 033695 765789

BQ804033-3F PIASTRA GHISA 21,3 x 44 cm PER BARBECUE TEXAS 3 FUOCHI+1

8 033695 765390

BQ804033-4F PIASTRA GHISA 37 x 44 cm PER BARBECUE TEXAS 4 FUOCHI+1

8 033695 765802



BQ804091-3F      TELO COPERTURA  
PER BARBECUE TEXAS 3 FUOCHI + 1



BQ804091-4F      TELO COPERTURA  
PER BARBECUE TEXAS 4 FUOCHI + 1



**ACCESSORI PER BARBECUE DAVIS E MONTANA**

BQ804125      SPARGI FIAMMA  
PER BARBECUE DAVIS E MONTANA



BQ804132      GRIGLIA IN ACCIAIO 41,5 X 22  
PER BARBECUE DAVIS E MONTANA 3F+1 e 5F+1



BQ804133      GRIGLIA IN ACCIAIO 41,5 X 35  
PER BARBECUE DAVIS E MONTANA 4F+1



BQ804134      GRIGLIA IN GHISA 41,5 X 35  
PER BARBECUE DAVIS E MONTANA 3F+1 e 5F+1



BQ804135      GRIGLIA IN GHISA 41,5 X 35  
PER BARBECUE DAVIS E MONTANA 4F+1



BQ804139      BRUCIATORE  
PER BARBECUE DAVIS



BQ804140      BRUCIATORE  
PER BARBECUE MONTANA



BQ804141      TELO DI COPERTURA  
PER BARBECUE DAVIS E MONTANA 3F+1



BQ804142      TELO DI COPERTURA  
PER BARBECUE DAVIS E MONTANA 4F+1



BQ804143      TELO DI COPERTURA  
PER BARBECUE DAVIS E MONTANA 5F+1



BQ804147      PIASTRA IN GHISA 41,5 X 35  
PER BARBECUE DAVIS E MONTANA 3F+1 e 5F+1



BQ804148      PIASTRA IN GHISA 41,5 X 22  
PER BARBECUE DAVIS E MONTANA 4F+1



BQ804095

**VALIGETTA CON ACCESSORI PER BARBECUE**

cm 36,8 x 9,8 x 7,8



0,9



12



Valigetta in alluminio, contenente 3 pezzi:  
1 forchettone 35 cm  
1 spatola 35 cm e 1 pinza 34,5 cm

BQ804096

**VALIGETTA CON ACCESSORI PER BARBECUE**

cm 48,5 x 20 x 7,8



2,2



6



Valigetta in alluminio contenente 5 pezzi:  
1 forchettone 40 cm, 1 spatola 42 cm,  
1 pinza 41 cm, 1 pennello 41 cm e 1 coltello 38 cm

BQ804098

**VALIGETTA CON ACCESSORI PER BARBECUE**

cm 49 x 26 x 8,5



3,1



6



Valigetta in alluminio 18 pezzi: 1 forchettone 40cm,  
1 spatola 42cm, 1 pinza 41cm, 1 pennello 41cm,  
1 coltello 40 cm, 1 spazzola 40cm, 2 spedini 41cm  
e 8 supporti per pannocchie

BQ804099

**VALIGETTA CON ACCESSORI PER BARBECUE**

cm 49 x 26 x 8,5



2,7



6



Valigetta in alluminio composta da 18 pezzi:  
1 forchettone 41cm, 1 spatola 42cm,  
1 pinza 40cm, 1 pennello 41cm, 6 spedini 41cm  
e 8 supporti per pannocchie

BQ804100

**VALIGETTA CON ACCESSORI PER BARBECUE**

cm 43 x 29 x 8



1,8



6



Valigetta in plastica composta da 18 pezzi:  
1 forchettone 37cm, 1 spatola 38cm, 1 pinza 37cm,  
1 pennello 32cm, 1 coltello 35 cm, 1 spazzola 30cm  
4 spedini 38cm e 8 supporti per pannocchie





CT804541

## TAVOLO CATERING 120

PIEGHEVOLE



cm 120 x 60 x 74 h



8



1



Struttura in metallo verniciato a polvere grigio  
tubo Ø 25x1,0 mm



Piano in ABS colore bianco



CT804539

## TAVOLO CATERING 240

PIEGHEVOLE



cm 240 x 76 x 74 h



16,8



1



Struttura in metallo verniciato a polvere  
tubo verniciato grigio Ø 28x1,0 mm



Piano in ABS bianco



CT804530

## TAVOLO CATERING

rettangolare



cm 180 x 75 x 74 h



13



1



Struttura in metallo verniciato a polvere col. grigio 25 x 1,0 mm



piano in ABS colore bianco



# Catering e contract



CT804531

**TAVOLO CATERING PIEGHEVOLE**



8 056772 889079

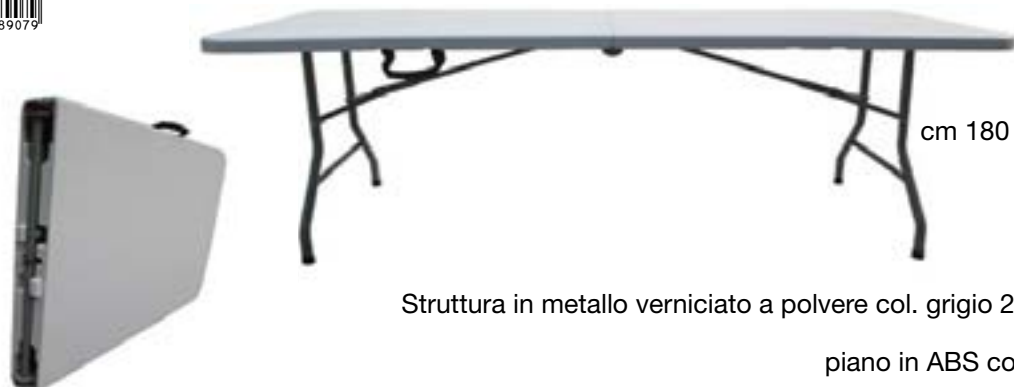

cm 180 x 75 x 74 h

12,5

1

Struttura in metallo verniciato a polvere col. grigio 25 x 1,0 mm

piano in ABS colore bianco

CT804534

**TAVOLO CATERING Ø 150**

PIEGHEVOLE



8 056772 889093



cm Ø 150 x 74 h

19,5

1

Struttura in metallo verniciato a polvere col. grigio 32 x 1,0 mm

piano in ABS colore bianco

CT804547

**TAVOLO CATERING 150**

PIEGHEVOLE



8 056099 356360



cm 150 x 70 x 74 cm

8,8

1

Struttura in metallo verniciato a polvere 25 x 1 mm

piano in ABS colore bianco

CT804533

**TAVOLO CATERING Ø 150**



8 056772 889086



cm Ø 150 x 74 h

19,5

1

Struttura in metallo verniciato a polvere grigio 25 x 1,0 mm

piano in ABS colore bianco

CT804548

**TAVOLO CATERING 90 X 90**

PIEGHEVOLE



8 056099 356377



cm 90 x 90 x 74 h

7

1

Struttura in metallo 25x1 mm verniciato a polvere grigio

piano in ABS bianco

CT804549

**TAVOLO CATERING Ø 120**

PIEGHEVOLE



8 058265 845272



cm Ø 120 x 74 h

17,5

1

Struttura in metallo verniciato a polvere col. grigio 32 x 1,0 mm

piano in ABS colore bianco



CT804550

**TAVOLO CATERING Ø 120**

PIEGHEVOLE



cm Ø 120 x 74 h

17,5

1

Struttura in metallo verniciato a polvere col. grigio 32 x 1,0 mm

piano in ABS colore bianco

CT804536

**SEDIA PIEGHEVOLE CATERING 1**



cm 86 x 40 x 39 h

5,4

25

Struttura in metallo verniciato a polvere grigio 25x1,0mm

seduta e schienale in ABS colore bianco

CT804546

**TAVOLO CATERING ALTO Ø 60**



cm Ø 60 x 110 h

6

1

Struttura in metallo verniciato a polvere  
Ø tubo verniciato grigio: 19 x 1,0 mm

piano in ABS bianco

CT804537

**SEDIA PIEGHEVOLE CATERING 2**



cm 44,5 x 43,5 x 83 h

5,6

25

Struttura in metallo verniciato a polvere grigio 19 x 1,0 mm

seduta e schienale in ABS colore bianco

CT804532

**TAVOLO CATERING ALTO Ø 80**



cm 80 x 110 h

8,8

1

Struttura in metallo  
verniciato a polvere 25 x 0,8 mm

piano in ABS colore bianco

CT804538

**PANCA PIEGHEVOLE CATERING**



cm 182 x 30 x 43 h

8,3

1

Struttura in metallo verniciato a polvere col. grigio 25 x 1,0 mm

seduta in ABS colore bianco



CT804521

**TAVOLO A COLONNA Ø 60**

waterproof



Ø cm 60 x 70 h

6,9

1

Struttura tubolare in alluminio Ø58x1,2mm- Øbase cm58

Tavolo con piano laminato in acciaio 304 spessore 0,31 mm-con bordo spessore 18 mm

CT804524

**TAVOLO A COLONNA 70x70**

waterproof



cm 70 x 70 x 70 h

10,7

1

Struttura tubolare in alluminio Ø28x1,5 mm anodizzato brillante

Tavolo con piano laminato in acciaio 304 spessore 0,31 mm-con bordo spessore 18 mm

CT804525

**TAVOLO A COLONNA Ø70**

waterproof



Ø cm 70 x 70 h

8,6

1

Struttura tubolare in alluminio Ø28x1,5mm anodizzato brillante

Tavolo con piano laminato in acciaio 304 spessore 0,31 mm-con bordo spessore 18 mm

CT804529

**TAVOLO IMPILABILE 70 X 70**

waterproof



cm 70 x 70 x 70 h

9,4

1

Struttura tubolare in alluminio anodizzato brillante Ø28x1,5mm

Tavolo impilabile con piano laminato in acciaio 304 spessore 0,31 mm con bordo spessore 18 mm

CT804522

**TAVOLO A COLONNA 60x60**

waterproof



cm 60 x 60 x 70 h

7,8

1

Struttura tubolare in alluminio Ø 58 x 1,2 mm Ø base cm 58

Tavolo con piano laminato in acciaio 304 spessore 0,31 mm-con bordo spessore 18 mm

CT804511

**POLTRONA IMPILABILE DOUBLE**

in alluminio , con braccioli



cm 55 x 60 x 79 h

2,5

19

Doppio tubo in alluminio anodizzato brillante Ø25x1,2mm, viti galvanizzate

100kg

Poltrona in alluminio



CT804512

**POLTRONA IMPILABILE 1,2**

con braccioli



8 033695 769671



cm 56 x 55 x 74 h

1,8

21

Tubo in alluminio anodizzato brillante Ø25x1,2mm  
viti galvanizzate e connettori in ABS

p.max 100kg

Poltrona impilabile con monotubo in alluminio

HF807064-VRD

**POLTRONA 3 POSIZIONI RELAX MIELE**

VERDE, CON CUSCINO



8 056099 351280



cm 84 x 60 x 100 h

8

1

Telaio in abete e traverse in faggio

100kg

Imbottitura di sfridi di spugna gomma piuma  
fodera in cotone 100%

HF807064-BLU

**POLTRONA 3 POSIZIONI RELAX MIELE**

BLU, CON CUSCINO



8 056099 351297



cm 84 x 60 x 100 h

8

1

Telaio in abete e traverse in faggio

100kg

Imbottitura di sfridi di spugna gomma piuma  
fodera in cotone 100%

HF807064-BORD

**POLTRONA 3 POSIZIONI RELAX MIELE**

BORDEAUX, CON CUSCINO



8 056099 351303



cm 84 x 60 x 100 h

8

1

Telaio in abete e traverse in faggio

100kg

Imbottitura di sfridi di spugna gomma piuma  
fodera in cotone 100%



HF807065-VRD

**POLTRONA 4 POSIZIONI FAGGIO**

VERDE, CON CUSCINO



8 056099 351310



cm 61 x 75 x 110 h

12

1

Poltrona realizzata interamente in faggio

100kg

Imbottitura in sagomati di poliuretano espanso poggiate su cinghie elastiche. Tessuto in policotone.



HF807065-BLU

**POLTRONA 4 POSIZIONI FAGGIO**

BLU, CON CUSCINO



8 056099 351327



cm 61 x 75 x 110 h

12

1

Poltrona realizzata interamente in faggio

100kg

Imbottitura in sagomati di poliuretano espanso poggiate su cinghie elastiche. Tessuto in policotone.



HF807065-BORD

**POLTRONA 4 POSIZIONI FAGGIO**

BORDEAUX, CON CUSCINO



8 056099 351334



cm 61 x 75 x 110 h

12

1

Poltrona realizzata interamente in faggio

100kg

Imbottitura in sagomati di poliuretano espanso poggiate su cinghie elastiche. Tessuto in policotone.



HF807066-VRD

**POLTRONA 4 POSIZIONI FAGGIO**

VERDE CON CUSCINO E PROLUNGA



8 052783 702130



cm 84/61x 75 x 110 h

14

1

Poltrona realizzata in faggio

100kg

Imbottitura in sagomati di poliuretano espanso poggiate su cinghie elastiche. Tessuto in policotone.



VANO ESTRAIBILE PER LA PROLUNGA

HF807066-BLU

**POLTRONA 4 POSIZIONI FAGGIO**

BLU CON CUSCINO E PROLUNGA



8 052783 702116



cm 84/61x 75 x 110 h

14

1

Poltrona realizzata in faggio

100kg

Imbottitura in sagomati di poliuretano espanso poggiate su cinghie elastiche. Tessuto in policotone.



VANO ESTRAIBILE PER LA PROLUNGA

HF807066-BORD

**POLTRONA 4 POSIZIONI FAGGIO**

BORDEAUX, CON CUSCINO E PROLUNGA



8 052783 702123



cm 84/61x 75 x 110 h

14

1

Poltrona realizzata in faggio

100kg

Imbottitura in sagomati di poliuretano espanso poggiate su cinghie elastiche. Tessuto in policotone.



VANO ESTRAIBILE PER LA PROLUNGA



HF807135-BEIG

**POLTRONA PARADISO MOD. CARRELLO**

SABBIA



8 058265 845067

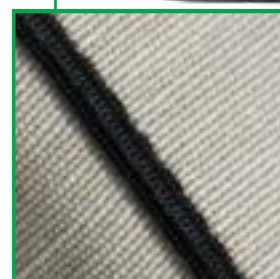

cm 155x60x60  
7,6  
1  
120 Kg

tubo ottagonale 35x20mm in metallo verniciato, reclinabile in 6 posizioni  
braccioli in polipropilene  
imbottitura in poliuretano e ovatta  
cuscino h. 6,5 cm  
con poggiatesta e poggiapiedi estraibile  
tessuto in policotone

HF807135-AZZ

**POLTRONA PARADISO MOD. CARRELLO**

PETROLIO



8 058265 845098

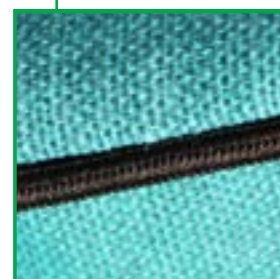

cm 155x60x60  
7,6  
1  
120 Kg

tubo ottagonale 35x20mm in metallo verniciato, reclinabile in 6 posizioni  
braccioli in polipropilene  
imbottitura in poliuretano e ovatta  
cuscino h. 6,5 cm  
con poggiatesta e poggiapiedi estraibile  
tessuto in policotone

HF807135-GREY

**POLTRONA PARADISO MOD. CARRELLO**

GRIGIA



8 058265 845074

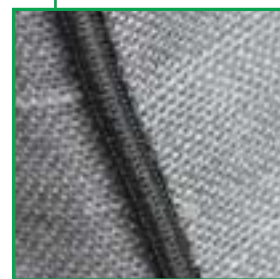

cm 155x60x60  
7,6  
1  
120 Kg

tubo ottagonale 35x20mm in metallo verniciato, reclinabile in 6 posizioni  
braccioli in polipropilene  
imbottitura in poliuretano e ovatta  
cuscino h. 6,5 cm  
con poggiatesta e poggiapiedi estraibile  
tessuto in policotone

HF807136-BEIG

**POLTRONA PARADISO MOD. AUTOMATICA**

SABBIA



8 058265 845104

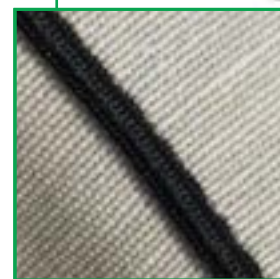

cm 155x60x60  
7,6  
1  
120 Kg

tubo ottagonale 35x20mm in metallo verniciato, reclinabile in 6 posizioni  
braccioli in polipropilene  
imbottitura in poliuretano e ovatta  
cuscino h. 6,5 cm  
con poggiatesta, tessuto in policotone

HF807135-RED

**POLTRONA PARADISO MOD. CARRELLO**

ROSSO ANTICO



8 058265 845081

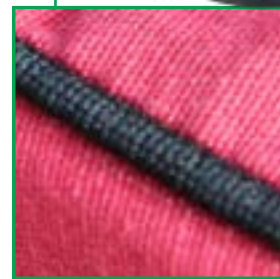

cm 155x60x60  
7,6  
1  
120 Kg

tubo ottagonale 35x20mm in metallo verniciato, reclinabile in 6 posizioni  
braccioli in polipropilene  
imbottitura in poliuretano e ovatta  
cuscino h. 6,5 cm  
con poggiatesta e poggiapiedi estraibile  
tessuto in policotone

HF807136- GREY

**POLTRONA PARADISO MOD. AUTOMATICA**

GRIGIA



8 058265 845111



cm 155x60x60  
7,6  
1  
120 Kg

tubo ottagonale 35x20mm in metallo verniciato, reclinabile in 6 posizioni  
braccioli in polipropilene  
imbottitura in poliuretano e ovatta  
cuscino h. 6,5 cm  
con poggiatesta, tessuto in policotone



HF807136-RED

**POLTRONA PARADISO MOD. AUTOMATICA**

ROSSO ANTICO



cm 155x60x60

7,6

1

tubo ottagonale 35x20mm in metallo verniciato, reclinabile in 6 posizioni  
braccioli in polipropilene

120 Kg

imbottitura in poliuretano e ovatta  
cuscino h. 6,5 cm  
con poggiatesta, tessuto in policotone

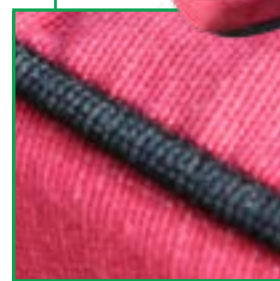

HF807136-AZZ

**POLTRONA PARADISO MOD. AUTOMATICA**

PETROLIO



cm 155x60x60

7,6

1

tubo ottagonale 35x20mm in metallo verniciato, reclinabile in 6 posizioni  
braccioli in polipropilene

120 Kg

imbottitura in poliuretano e ovatta  
cuscino h. 6,5 cm  
con poggiatesta, tessuto in policotone



HF807137-BVRD

**SDRAIO CIPRO MODELLO MOD. CARRELLO**

BLU E AZZURRO SCOZZESE



cm 155x60x60

6,8

1

tubo in metallo nero ottagonale 35x20mm, reclinabile in 6 posizioni  
braccioli in polipropilene

120 Kg

tessuto poliestere  
cuscino h. 4 cm, poggiatesta estraibile



HF807138-BVRD

**SDRAIO CIPRO MOD. AUTOMATICO**

BLU E AZZURRO SCOZZESE



cm 155x60x60

6,8

1

tubo in metallo nero ottagonale 35x20mm, reclinabile in 6 posizioni  
braccioli in polipropilene

120 Kg

tessuto poliestere  
cuscino h. 4 cm



HF807139-ABLU

**SDRAIO RODI MOD. CARRELLO**

BLU E AZZURRO SCOZZESE



cm 155x60x60

7,2

1

tubo in metallo nero ottagonale 35x20mm, reclinabile in 6 posizioni  
braccioli in polipropilene

120 Kg

tessuto poliestere  
cuscino h. 7 cm, poggiatesta estraibile



HF807140-ABLU

**SDRAIO RODI MOD. AUTOMATICO**

BLU E AZZURRO SCOZZESE



cm 155x60x60

7,2

1

tubo in metallo nero ottagonale 35x20mm, reclinabile in 6 posizioni  
braccioli in polipropilene

120 Kg

tessuto poliestere  
cuscino h. 7 cm





HF807137-GARA

**SDRAIO CIPRO MODELLO CARRELLO**

ARANCIO E GIALLO SCOZZESE



cm 155x60x60  
6,8  
1

tubo in metallo nero ottagonale  
35x20mm, reclinabile in 6 posizioni  
braccioli in polipropilene

120 Kg

tessuto poliestere  
cuscino h. 4 cm, poggiatesta estraibile

HF807138-GARA

**SDRAIO CIPRO MODELLO AUTOMATICO**

ARANCIO E GIALLO SCOZZESE

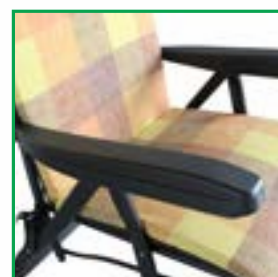

cm 155x60x60  
6,8  
1

tubo in metallo nero ottagonale  
35x20mm, reclinabile in 6 posizioni  
braccioli in polipropilene

120 Kg

tessuto poliestere  
cuscino h. 4 cm

HF807137-GVRD

**SDRAIO CIPRO MODELLO CARRELLO**

VERDE E GIALLO SCOZZESE



cm 155x60x60  
6,8  
1

tubo in metallo nero ottagonale  
35x20mm, reclinabile in 6 posizioni  
braccioli in polipropilene

120 Kg

tessuto poliestere  
cuscino h. 4 cm, poggiatesta estraibile

HF807138-GVRD

**SDRAIO CIPRO MODELLO AUTOMATICO**

VERDE E GIALLO SCOZZESE



cm 155x60x60  
6,8  
1

tubo in metallo nero ottagonale  
35x20mm, reclinabile in 6 posizioni  
braccioli in polipropilene

120 Kg

tessuto poliestere  
cuscino h. 4 cm



HF807139-VGRE

**SDRAIO RODI MODELLO CARRELLO**

VERDE E GRIGIO SCOZZESE



cm 155x60x60

7,2

1

tubo in metallo nero ottagonale  
35x20mm, reclinabile in 6 posizioni  
braccioli in polipropilene

120 Kg

tessuto poliestere  
cuscino h. 7 cm, poggiatesta estraibile

HF807144-GAZZ

**SDRAIO HAITI MODELLO CARRELLO**

GRIGIO E AZZURRO SCOZZESE

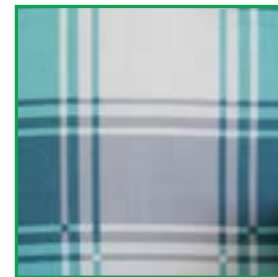

cm 155x60x60

6,8

1

tubo in metallo nero ottagonale 35x20mm  
reclinabile in 6 posizioni  
braccioli in polipropilene

120 Kg

tessuto poliestere  
cuscino h. 7 cm, poggiatesta estraibile

HF807140-VGRE

**SDRAIO RODI MODELLO AUTOMATICO**

VERDE E GRIGIO SCOZZESE

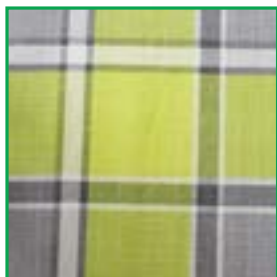

cm 155x60x60

7,2

1

tubo in metallo nero ottagonale  
35x20mm, reclinabile in 6 posizioni  
braccioli in polipropilene

120 Kg

tessuto poliestere  
cuscino h. 7 cm





## Dondoli

D0801013-BEIG

### DONDOLO LETTO RELAX CON CUSCINI



8 033695 766977



cm 230x120x164 h ↗

49

1

struttura in metallo nero, tubi  $\varnothing$  48/32/28/16 mm

p. max 260kg ↓

Tetto poliestere 180gr/m<sup>2</sup> beige, cuscino beige oxford spessore 8 cm

D0801019

### DONDOLO JIM



8 056099 350207



cm 202 x 114 x 169 h ↗

41

1

struttura in metallo nero opaco, tubi  $\varnothing$  50/32/28/18 mm

p. max 260kg ↓

Tetto poliestere 180gr/m<sup>2</sup> beige, cuscino beige oxford spessore 8 cm



D0801030

**DONDOLO ZANZIBAR**



8 053695 760432



cm 198 x 140 x 174 h ↗

35

1

Struttura in metallo TORTORA Ø 95x186 h

portata max. 260kg ↓

seduta TORTORA 83 x 67 x 122 h cuscino 250 gr TORTORA



D0801017-MRNE

**DONDOLO ANTIGUA**

CON CUSCINI



8 056099 350306



cm 208 x 116 x 168 h ↗

36

1

struttura in metallo ANTRACITE tubi Ø 28/37x63mm

portata max. 260 kg ↓

Telo poliestere 220 gr/m<sup>2</sup>  
cuscino MARRONE RIGATO poliestere

D0801017

**DONDOLO ANTIGUA CON CUSCINI**



8 056772 883060



cm 208 x 116 x 168 h ↗

36

1

struttura in metallo antracite tubi diam. 28/37x63mm

portata max. 260kg ↓

Tetto poliestere 220 gr/m<sup>2</sup>, cuscino beige poliestere

D0801025

**DONDOLO CICLADI**



8 052783 701720



Cm170x136x170h ↗

38

1

Struttura nera, tubi in metallo Ø 48 x 1,2 mm

Telo poliestere 180gr/m<sup>2</sup> tortora  
tessuto 300x600 gr oxford TORTORA con sedute separate



D0801014

**DONDOLO TEXTY**



cm 195 x 120 x 172 h

32,5

1

struttura in metallo nero tubi  $\varnothing$  48/32/25mm

p. max 260kg

Tetto poliestere 160gr/m<sup>2</sup> beige, schienale e seduta in textilene 2x1 grigio

D0801029

**DONDOLO NAXOS**



cm 186 x 114 x 162 h

31

1

Struttura BIANCA textilene 2 x 1 GRIGIO CHIARO, tubi in metallo  $\varnothing$  38 x 1/20 x 30 mm, telo in poliestere 160 gr GRIGIO CHIARO

D0801026

**DONDOLO LACONIA**



cm 1210x197x169h

38

1

Struttura BIANCA textilene 2x1GRIGIO, tubi in metallo 63x3/35x20mm, telo in poliestere 160 gr GRIGIO

D0801011

**DONDOLO GREEN CON CUSCINI**



cm 170 x 110 x 153 h

20

1

Struttura in metallo verde, tubi  $\varnothing$  45/32/25/19/16 mm

portata max. 260kg

Tetto poliestere 160gr/m<sup>2</sup> verde, cuscino righe verdi



CU805737

**TELO PER TETTO DONDOLO 3 POSTI**

ECRÙ



8 058265 845715



cm 200 x 112 ↙  
1 📦  
poliestere  
idrorepellente

CU805740

**TELO PER TETTO DONDOLO 2 POSTI**

ECRÙ



8 058265 845746



cm 165 x 112 ↙  
1 📦  
poliestere  
idrorepellente

CU805738

**TELO PER TETTO DONDOLO 3 POSTI**

VERDE



8 058265 845722

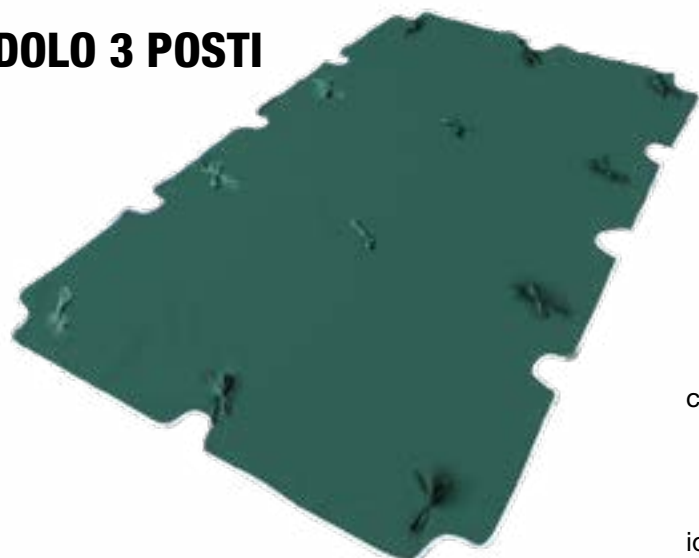

cm 200 x 112 ↙  
1 📦  
poliestere  
idrorepellente

CU805741

**TELO PER TETTO DONDOLO 2 POSTI**

VERDE



8 058265 845753

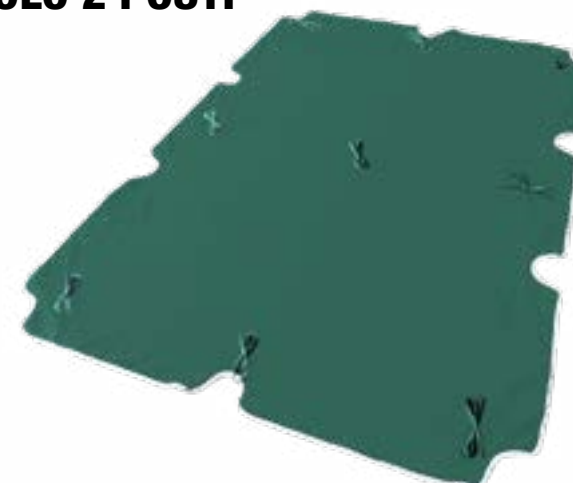

cm 165 x 112 ↙  
1 📦  
poliestere  
idrorepellente

CU805739

**TELO PER TETTO DONDOLO 3 POSTI**

TORTORA



8 058265 845739



cm 200 x 112 ↙  
1 📦  
poliestere  
idrorepellente

CU805742

**TELO PER TETTO DONDOLO 2 POSTI**

TORTORA



8 058265 845760



cm 165 x 112 ↙  
1 📦  
poliestere  
idrorepellente



C0803001  
**TELO DI COPERTURA  
PER TAVOLO RETTANGOLARE M**



8 058265 845715



cm 180 x 110 x 60 h ↗



custodia in poliestere 🍯

C0803005  
**TELO DI COPERTURA  
PER TAVOLO ROTONDO S**



8 051811 460417



cm Ø120 x 60 h ↗



custodia in poliestere 🍯

C0803002  
**TELO DI COPERTURA  
PER TAVOLO RETTANGOLARE L**



8 051811 460387



cm 200 x 130 x 60 h ↗



custodia in poliestere 🍯

C0803006  
**TELO DI COPERTURA  
PER TAVOLO ROTONDO M**



8 051811 460424



cm Ø160 x 60 h ↗



custodia in poliestere 🍯

C0803003  
**TELO DI COPERTURA  
PER TAVOLO RETTANGOLARE XL**



8 051811 460394



cm 240 x 130 x 60 h ↗



custodia in poliestere 🍯

C0803007  
**TELO DI COPERTURA  
PER LETTINO**



8 051811 460431



cm 200 x 75 x 45 h ↗



custodia in poliestere 🍯

C0803004  
**TELO DI COPERTURA  
PER TAVOLO RETTANGOLARE XXL**



8 051811 460401



cm 310 x 130 x 60 h ↗



custodia in poliestere 🍯

C0803008  
**TELO DI COPERTURA  
PER PILA DI SEDIE**



8 051811 460448



cm 66 x 66 x 80/120 h ↗



custodia in poliestere 🍯



C0803009  
**TELO DI COPERTURA  
PER MOBILE**



cm 75 x 75 x 60 h ↗



custodia in poliestere 🧺

C0803013  
**TELO DI COPERTURA  
PER BARBECUE XL**



cm 102 x 46 x 92 h ↗



custodia in poliestere 🧺

C0803010  
**TELO DI COPERTURA  
PER DIVANO 2 POSTI**



cm 130 x 75 x 60 h ↗



custodia in poliestere 🧺

C0803014  
**TELO DI COPERTURA  
PER BARBECUE XXL**



cm 150 x 60 x 90 h ↗



custodia in poliestere 🧺

C0803011  
**TELO DI COPERTURA  
PER DIVANO 3 POSTI**



cm 205 x 75 x 60 h ↗



custodia in poliestere 🧺

C0803015  
**TELO DI COPERTURA  
PER BARBECUE ROTONDO S**



cm Ø x 60 x 80 h ↗



custodia in poliestere 🧺

C0803012  
**TELO DI COPERTURA  
PER DONDOLO**



cm 215 x 155 x 150 h ↗



custodia in poliestere 🧺

C0803016  
**TELO DI COPERTURA  
PER BARBECUE ROTONDO M**



cm Ø x 70 x 80 h ↗



custodia in poliestere 🧺



C0803017  
**TELO DI COPERTURA  
PER TAVOLO DA PING PONG**



8 051811 460530



cm 190 x 75 x 175 h ↙  
1 📦  
custodia in poliestere 📦

C0803018  
**TELO DI COPERTURA  
PER OMBRELLONE S**



8 051811 460547



cm 31 x 31 x 200 h ↙  
1 📦  
custodia in poliestere 📦

C0803019  
**TELO DI COPERTURA  
PER OMBRELLONE M**



8 051811 460554



cm 57 x 23 x 210 h ↙  
1 📦  
custodia in poliestere 📦

C0803020  
**TELO DI COPERTURA  
PER OMBRELLONE L**



8 051811 460561



cm 60 x 70 x 240 h ↙  
1 📦  
custodia in poliestere 📦



Giochi da giardino



AL806771

**TRAMPOLINO ELASTICO**

Ø 244 CM,



Ø cm 244 x 65/245 h  
47  
1  
struttura zincata tubi  
38mm x 1,4 mm  
gambe 34mm x1,35mm  
p. max 100kg  
Trampolino elastico con rete Ø 244 CM

AL806772

**TRAMPOLINO ELASTICO**

Ø 305 CM



Ø cm 305 x 65/245 h  
56  
1  
struttura zincata  
tubi 38mm x 1,4 mm  
gambe 34mm x1,35mm  
p. max 160kg  
Trampolino elastico con rete Ø 305 CM

AL806773

**TRAMPOLINO ELASTICO**

Ø 366 CM



Ø cm 366 x 89/269 h  
70,3  
1  
struttura zincata  
tubi 42mm x 1,4 mm,  
gambe 38mm x1,35mm  
p.max 160kg  
Trampolino elastico con rete Ø 366 CM

AL806780

**RETE DI SICUREZZA PER TRAMPOLINO Ø 244 CM**



AL806781

**RETE DI SICUREZZA PER TRAMPOLINO Ø 305 CM**



AL806782

**RETE DI SICUREZZA PER TRAMPOLINO Ø 366 CM**



AL806783

**CUSCINETTO PER TRAMPOLINO Ø 244 CM**





AL806784

## CUSCINETTO PER TRAMPOLINO Ø 305 CM



AL806791

## KIT MOLLE PER TRAMPOLINO Ø 366 CM



AL806785

## CUSCINETTO PER TRAMPOLINO Ø 366 CM



AL806819

## RETE ELASTICA PER TRAMPOLINO Ø 244 CM



AL806789

## KIT MOLLE PER TRAMPOLINO Ø 244 CM



AL806820

## RETE ELASTICA PER TRAMPOLINO Ø 305 CM



AL806790

## KIT MOLLE PER TRAMPOLINO Ø 305 CM



AL806821

## RETE ELASTICA PER TRAMPOLINO Ø 366 CM





AL806702

**ALTALENA MINNIE 5 POSTI**



m 2,90x1,90x1,95h  
42,5  
1  
tubi ø 50/25mm  
Altalena in metallo 5posti



AL806704

**ALTALENA MINNIE 2 POSTI**



m2,20x1,80x1,80h  
25  
1  
tubi ø 50/45mm  
Altalena in metallo - 2 posti



AL806703

**ALTALENA MINNIE 4 POSTI**



m 2,90x1,90x1,95h  
31  
1  
tubi ø 50/25 mm  
Altalena in metallo



AL806705

**ALTALENA MINNIE 1 POSTO**



m1,60x1,80x1,80 h  
19,5  
1  
tubi ø 50x45  
Altalena in metallo - 1posto





AL806836

**ALTALENA IN LEGNO ARIEL 1 POSTO**



8 051811 462541



cm 223 x 264 x 226 h

81

1

Altalena in legno 1 posto

AL806837

**ALTALENA IN LEGNO ARIEL 2 POSTO**



8 051811 462556



cm 313 x 264 x 226 h

96

1

Altalena in legno 2 posti

AL806707

**SCALETTA**



8 033695 766854



legno 30 x ø 2,2cm

0,5

20

scaletta in corda ø 10mm,  
5 pioli in legno 25x300 mm

AL806711

**SEGGIOLINO CHIUSO**



8 033695 766892



cm 36x42x40 / 300h

1,4

12

Seggiolino chiuso

AL806708

**DISCO**



8 033695 766861



ø 30 cm

0,6

10

corda in PE ø 11mm

AL806709

**SEGGIOLINO SINGOLO**



8 033695 766878



cm 38 x 16

1,1

22

Seggiolino singolo in ABS  
corda in PE ø10mm

AL806710

**TRAPEZIO**



8 033695 766885



0,6

20

Trapezio in ABS - corde in PE



AL806845

**SCIVOLO**



cm 120 x 55 x 73 h

8

1

Scivolo resistente e sicuro  
Colori brillanti e resistenti alla luce del sole. Bambini 1+

AL806847

**SCIVOLO ACTIVITY CENTER**



cm 29 x 103 x 79 h

12,3

1

Scivolo con attività multiple, robusto,  
acile da montare e con sistema Anti-UV. Bambini 2+

AL806846

**SCIVOLO CURVE**



cm 137 x 175 x 125 h

15

1

Scivolo con curva, resistente e sicuro  
Colori brillanti e resistenti alla luce del sole. Bambini 3+

AL806848

**SCIVOLO ACTIVITY PARK**



cm 84 x 167 x 101 h

20

1

Scivolo con attività multiple  
Robusto, facile da montare e con sistema Anti-UV  
Bambini 2+



AL806809

**CASSETTA BOSCO**



8 410779 595904



cm 200 x 125 x 139 h

30

1

Casetta del bosco con scivolo e due scalette di salita laterali, con una panca trasformabile in contenitore per la sabbia Bambini 3+

AL806807

**MEGA SCIVOLO CON ACQUA**



8 410779 597090



cm 302 x 117 x 209 h

32

1

Scivolo mega di grandi dimensioni, con sponde alte, dotato di innesto per la canna dell'acqua, colori luminosi. Portata max 80 kg Bambini 3+

AL806806

**SUPER MEGA SCIVOLO CON ACQUA**



8 410779 595942



cm 253 x 80 x 140 h

20

1

Super scivolo di grandi dimensioni, con scaletta di salita antiscivolo, con sponde alte per una maggiore sicurezza. Portata max 45 kg Bambini 3+

AL806804

**SCIVOLO PLUS**



8 410779 590015



cm 119 x 42 x 28 h

7

1

Scivolo resistente e sicuro grazie alle sponde alte, dotato di innesto per la canna dell'acqua, colori brillanti Portata max 30 kg Bambini 2+



AL806805

**SCIVOLO CON ACQUA**



8 410779 595928



cm 193 x 97 x 126 h

13

1

Scivolo con sponde alte, dotato di innesto per la canna dell'acqua, colori luminosi Portata max 45 kg Bambini 3+

AL806852

**SCIVOLO MAX CON ACQUA**



8 411845 022515



cm 161x71x103 h

7,7

1

Scivolo con acqua Robusto, facile da montare e con sistema Anti-UV. Bambini 2+

AL806720

**SCIVOLO ONDA**



8 034076 142786



cm 285 x 150 x 168 h

14,2

1

AL806853

**SCIVOLO CLIMB**



8 411845 021945



cm 130 x 108 x h 134,5 h

18

1

Scivolo con scaletta e parete da arrampicata Robusto, facile da montare e con sistema Anti-UV. Bambini 3+



AL806815

**TAVOLINO PLAY ISLAND**



cm 70 x 70 x 46 h

5,9

1

Tavolo da gioco suddiviso in due aree tematiche sabbia ed acqua accessori inclusi, possibilità di trasformarlo in un tavolino di appoggio grazie al coperchio. Bambini 2+

AL806810

**TAVOLO PIC NIC / DONDOLINO FANTASMA**



cm 109 x 125 x 85 h

30

1

Da un lato è un classico tavolino da pic-nic con quattro posti, capovolgendolo un dondolo comodo montaggio facile. Portata max 80 kg Bambini 3+

AL806816

**SALI SCENDI 2 X 2**



cm 234 x 60 x 97 h

15,5

1

Sali-scendi con barra di ferro rinforzata garantisce una resistenza di 200 kg Regolabile in tre altezze, quattro posti Bambini 3+

AL806808

**BRUCO**



cm 170 x 100 x 108 h

20

1

I suoi moduli colorati permettono di montarlo in differenti conformazioni, facile da montare e molto divertente nella sua semplicità Bambini 3+



AL806854

**CASA NELL'ALBERO**



151 x 50 x h 116.5 cm

35 KG

1 PZ

con scale di accesso, porte e finestre che si aprono e si chiudono  
colori vivaci e resistente ai raggi UV  
Robusta e facile da montare, Bambini 3+

AL806838

**CASSETTA ECO HOUSE**



cm 150 x 150 x 165 h

16,4 KG

1 PZ

Casetta da gioco che include attività di apprendimento sulla natura  
Robusta, facile da montare e con sistema Anti-UV. Bambini 2+

AL806844

**SUPER PALAZZO**



cm 123 x 100 x 102 h

54 KG

1 PZ

Castello delle Principesse  
Robusto, facile da montare e con sistema Anti-UV  
Bambini 2+

AL806839

**CASSETTA FOOD TRUCK**



cm 130 x 108 x h 134,5 h

23 KG

1 PZ

Food Truck da gioco che include più di 50 accessori  
facile da montare e con sistema Anti-UV. Bambini 2+



AL806802

**CASSETTA**



cm131x110x121h

25

1

Casetta da gioco con finestre che si aprono e si chiudono, porta con finta chiave, colori luminosi e resistenti alla luce del sole ed al cambio di temperatura. Bambini 2+

AL806814

**WOODLAND COTTAGE CON SUONI**



86 x 82 x 130,5 h

64

1

Casetta da gioco molto spaziosa con porta e finestra apribile contiene due comode panchine scorrevoli, un fantastico campanello con suoni elettronici, Bambini 2+

AL806801

**CASSETTA FANTASIA**



cm 85x108x124h

15

1

Casetta con porta apribile, Colori luminosi, Resistente alla luce del sole ed al cambio di temperatura. Bambini 2+

AL806840

**CASSETTA MULTI ACTIVITY 6X1**



cm 142 x 85 x 124 h

17

1

Casetta da gioco che include accessori per bowling, tennis, calcio, pallacanestro e bersaglio per palline Bambini 3+



AL806842

**CASSETTA HAPPY**



cm 80 x 94 x 100 h

9,5

1

Casetta da gioco con due ingressi, fessura per la chiave e buca per le lettere  
Robusta, facile da montare e con sistema Anti-UV, Bambini 2+

AL806779

**CASSETTA VILLAGE**



cm 140 x 108 x 115 h

13,2

1

AL806843

**CASSETTA GRANDE VILLA**



cm 199,9 x 154 x 180 h

46

1

Casetta da gioco di grandi dimensioni, con ampio spazio interno, porta e finestre apribili, colori luminosi e resistenti alla luce del sole ed al cambio di temperatura Bambini 3+

AL806817

**CASSETTA MAGICA**



cm 102,5 x 89 x 109 h

16,5

1

Casetta con porta e finestre apribili, Colori luminosi, Resistente alla luce del sole ed al cambio di temperatura. Bambini 2+







# Outdoor Living

Magazzini Cosma snc

Viale Europa 20/22  
36020 Pove del Grappa -VI-

tel: 0424/808617  
fax:0424/1940744

[info@cosmarredogiardino.com](mailto:info@cosmarredogiardino.com)

P.iva 00852310267

[b2b.magazzinicosma.it](http://b2b.magazzinicosma.it)

